

MxL Plus

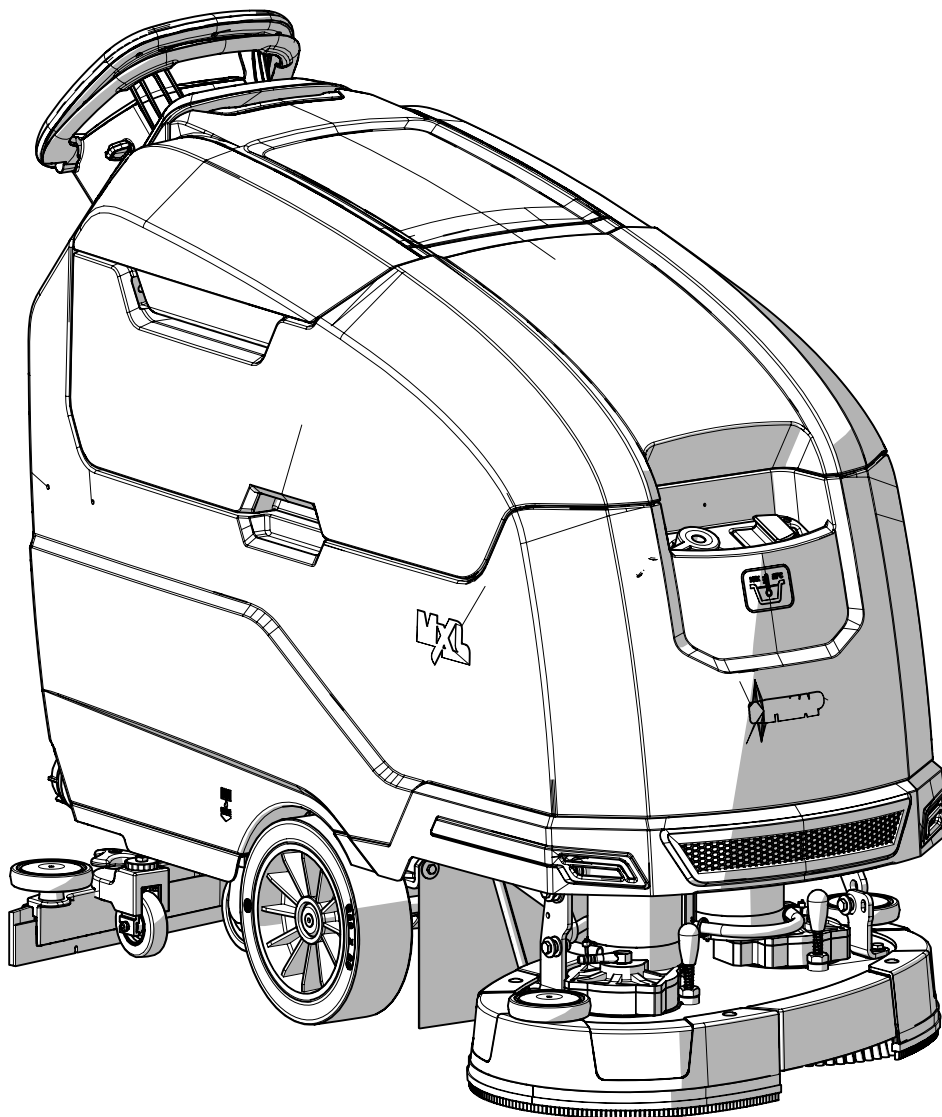

PROFESSIONAL SCRUBBING MACHINES

## *USE AND MAINTENANCE MANUAL*

 **FIMAP**<sup>®</sup>



ORIGINAL INSTRUCTIONS DOC. 10084109 - Ver. AA - 02-2019



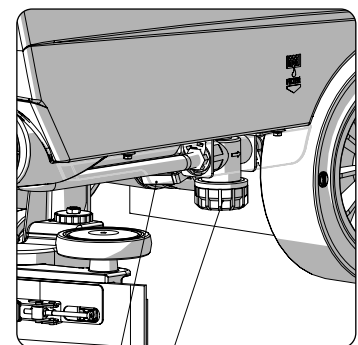
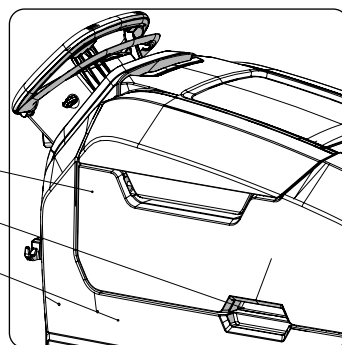
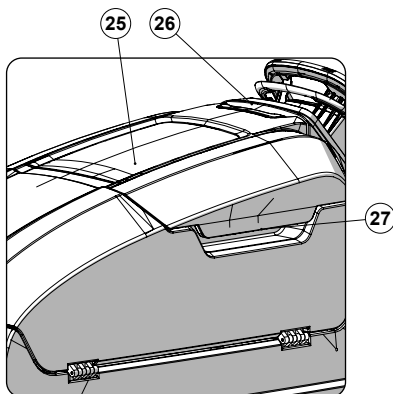
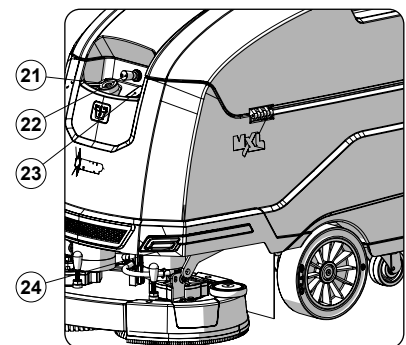
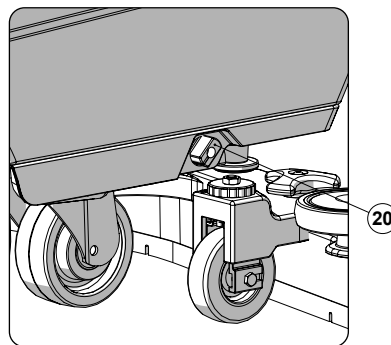
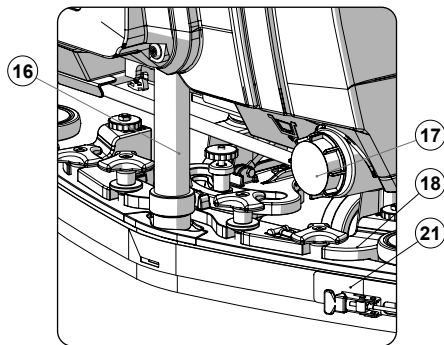
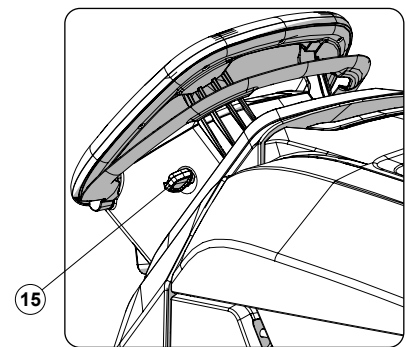
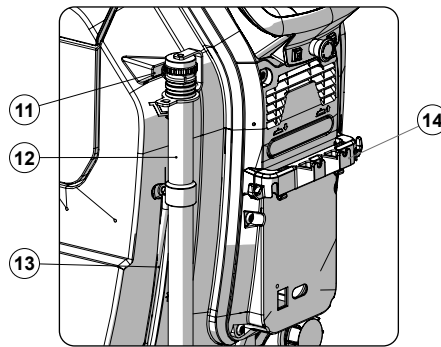
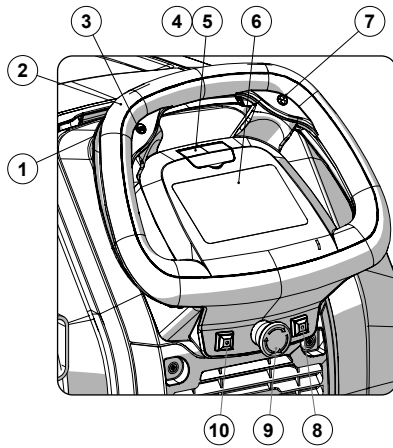

## MAIN MACHINE COMPONENTS

The machine's main components are the following:

1. Dead man's lever.
2. Control handlebars.
3. Eco Mode button.
4. Cover for FFM "FIMAP FLEET MANAGEMENT" SOS button (Optional).
5. FFM "FIMAP FLEET MANAGEMENT" SOS button (Optional).
6. Control panel and control display.
7. Reverse control button.
8. FSS "FIMAP SOLUTION SAVER" control switch (optional) or FLR "FIMAP LONG RANGE" control switch (optional).
9. Battery disconnect button.
10. "TANK CLEANING GUN" control switch (optional) or "LIQUID VACUUM WAND" control switch (optional).
11. Support hook for recovery tank drainage tube.
12. Recovery tank drainage hose.
13. Solution tank level indicator.
14. Accessories support.
15. Main key switch.
16. Vacuum tube.
17. Solution tank drainage cap.
18. Squeegee body support.
19. Squeegee body.
20. Water flow adjustment tap.
21. Solution tank filler tube cap.
22. Cover cap for FFF "FIMAP FAST FILL" quick coupling kit (optional).
23. Solution tank filler cap/measuring inlet.
24. Front headlight (optional).
25. Accessory compartment door.
26. Control handle for accessory compartment door.
27. Recovery tank cover lifting handle.
28. Recovery tank.
29. Recovery tank lifting handle.
30. Solution tank.
31. Electric brake control lever
32. Detergent solution filter.

## CONTENTS

<b>MAIN MACHINE COMPONENTS</b> .....	<b>3</b>
<b>CONTENTS</b> .....	<b>4</b>
<b>GENERAL SAFETY REGULATIONS</b> .....	<b>6</b>
<b>SYMBOLS USED IN THE MANUAL</b> .....	<b>6</b>
<b>PURPOSE AND CONTENT OF THE MANUAL</b> .....	<b>7</b>
<b>STORING THE USE AND MAINTENANCE MANUAL</b> .....	<b>7</b>
<b>ON CONSIGNMENT OF THE MACHINE</b> .....	<b>7</b>
<b>INTRODUCTORY COMMENT</b> .....	<b>7</b>
<b>IDENTIFICATION DATA</b> .....	<b>7</b>
<b>TECHNICAL DESCRIPTION</b> .....	<b>7</b>
<b>INTENDED USE</b> .....	<b>7</b>
<b>SAFETY</b> .....	<b>7</b>
<b>REGULATIONS</b> .....	<b>7</b>
<b>TARGET GROUP</b> .....	<b>7</b>
<b>SERIAL NUMBER PLATE</b> .....	<b>8</b>
<b>TECHNICAL DATA</b> .....	<b>8</b>
<b>DISPOSAL</b> .....	<b>9</b>
<b>SYMBOLS USED ON THE MACHINE</b> .....	<b>10</b>
SYMBOLS PRESENT ON THE REGISTRATION PLATE.....	10
SYMBOLS PRINTED ON THE MACHINE.....	10
LABELS USED ON THE MACHINE.....	10
<b>TOUCH SCREEN DISPLAY</b> .....	<b>11</b>
CONTROL SCREEN.....	11
INFORMATION FIELD.....	11
<b>PREPARATION OF MACHINE</b> .....	<b>12</b>
HANDLING THE PACKAGED MACHINE.....	12
HOW TO UNPACK THE MACHINE.....	12
HOW TO MOVE THE MACHINE.....	13
MACHINE SAFETY.....	13
TYPE OF BATTERY TO BE USED.....	14
BATTERY MAINTENANCE AND DISPOSAL.....	14
INSERTING THE BATTERIES IN THE MACHINE.....	14
RECHARGING THE BATTERIES.....	14
ASSEMBLING THE BRUSH (SCRUBBING VERSION).....	15
ASSEMBLING THE BRUSH (SWEEPING VERSION).....	15
ASSEMBLING THE SQUEEGEE BODY.....	15
INSERTING WATER SYSTEM FILTER.....	16
FILLING THE SOLUTION TANK WITH WATER.....	16
DETERGENT SOLUTION (VERSIONS WITHOUT FSS).....	16
FILLING THE DETERGENT CANISTER (VERSIONS WITH FSS).....	16
<b>PREPARING TO WORK</b> .....	<b>17</b>
<b>STARTING WORK</b> .....	<b>18</b>
HOUR METER.....	21
DS SELECTOR (DRIVE SELECT).....	21
BATTERY CHARGE LEVEL INDICATOR.....	21
TRANSFER.....	20
SCRUBBING WITHOUT DRYING.....	20
DRYING.....	21
SCRUBBING WITH DRYING.....	22
ECO MODE.....	23
MANUAL MODE.....	24
PROGRAM ZONE MODE.....	25
SMART DRYING MODE.....	25

REVERSE GEAR.....	25
EXTRA BRUSH HEAD PRESSURE .....	26
FIMAP SOLUTION SAVER SYSTEM (FSS) .....	26
FIMAP LONG RANGE (FLR) SYSTEM.....	26
AUTOMATIC REQUEST FOR TECHNICAL ASSISTANCE (FFM VERSIONS) .....	27
TUTORIAL.....	27
VACUUM WAND KIT.....	28
SPRAY GUN KIT.....	28
ALARM SCREEN.....	29
BATTERY DISCONNECT SWITCH .....	29
OVERFLOW DEVICE .....	29
<b>AT THE END OF THE WORK.....</b>	<b>30</b>
<b>RECOMMENDED MAINTENANCE OPERATIONS .....</b>	<b>30</b>
CLEANING THE SQUEEGEE BODY.....	31
CLEANING THE DEBRIS HOPPER (SWEEPING VERSION) .....	32
CLEANING THE BRUSH HEAD BRUSHES (SCRUBBING VERSION).....	32
CLEANING THE BRUSH HEAD BRUSHES (SWEEPING VERSION).....	32
DRAINING THE RECOVERY TANK .....	32
CLEANING THE RECOVERY TANK FILTERS.....	32
CLEANING THE VACUUM TUBE.....	33
EMPTYING THE SOLUTION TANK.....	33
CLEANING THE WATER SYSTEM FILTER .....	33
<b>EXTRAORDINARY MAINTENANCE WORK.....</b>	<b>33</b>
REPLACING THE BRUSH (SCRUBBING VERSION) .....	33
REPLACING THE BRUSH (SWEEPING VERSION) .....	33
REPLACING THE SQUEEGEE BODY RUBBER BLADES.....	34
<b>ADJUSTMENT INTERVENTIONS.....</b>	<b>34</b>
ADJUSTING THE SQUEEGEE BODY'S RUBBER BLADES .....	34
<b>CHOOSING AND USING BRUSHES .....</b>	<b>35</b>
<b>TROUBLESHOOTING.....</b>	<b>36</b>
<b>EC DECLARATION OF CONFORMITY .....</b>	<b>37</b>















The descriptions contained in this document are not binding. The company therefore reserves the right to make any modifications at any time to elements, details, or accessory supply, as considered necessary for reasons of improvement or manufacturing/commercial requirements. The reproduction, even partial, of the text and drawings contained in this document is prohibited by law.

The company reserves the right to make any technical and/or supply modifications. The images are for reference purposes only, and are not binding in terms of design and supply.

## GENERAL SAFETY REGULATIONS

Before using the machine, please read the following document carefully and follow the instructions contained herein, along with the instructions in the document supplied with the machine itself, "GENERAL SAFETY REGULATIONS" (document code 10083659).

## SYMBOLS USED IN THE MANUAL

	<b>Open book symbol with an "i":</b> Indicates the need to consult the instruction manual.
	<b>Open book symbol:</b> Tells the operator to read the user manual before using the device.
	<b>Covered place symbol:</b> The operations preceded by this symbol must always be carried out in a dry, covered area.
	<b>Information symbol:</b> Indicates additional information for the operator, to improve the use of the device.
	<b>Warning symbol:</b> Carefully read the sections preceded by this symbol meticulously following the instructions indicated for the safety of the operator and the device.
	<b>Danger symbol (corrosive substances):</b> The operator should always wear protective gloves to avoid the risk of serious injury to the hands caused by corrosive substances.
	<b>Danger symbol (battery acid leakage):</b> Indicates the danger of leaking acid or acid fumes from the batteries while they are being recharged.
	<b>Danger symbol (moving carriages):</b> Indicates that the packed product should be handled with suitable carriages that conform to legal requirements.
	<b>Mandatory room ventilation symbol:</b> Informs the operator that the room must be ventilated while the batteries are being recharged.
	<b>Symbol indicating the compulsory use of protective gloves:</b> Indicates that the operator should always wear protective gloves, to avoid the risk of serious injury to his hands from sharp objects.
	<b>Symbol indicating the compulsory use of tools:</b> Informs the operator of the need to use tools not included with the machine.
	<b>Symbol indicating a treading ban:</b> Informs the operator that it is forbidden to tread on machine components, as this could lead to serious injury.
	<b>Recycling symbol:</b> Tells the operator to carry out the operations in compliance with environmental regulations in force in the place where the appliance is being used.
	<b>Disposal symbol:</b> Carefully read the sections marked with this symbol for disposing of the appliance.

## PURPOSE AND CONTENT OF THE MANUAL

The aim of this manual is to provide customers with all the information needed to use the machine in the safest, most appropriate and most autonomous way. This includes information concerning technical aspects, safety, operation, downtime, maintenance, spare parts and scrapping. The operators and qualified technicians must carefully read the instructions in this manual before carrying out any operations on the machine. If in doubt about the correct interpretation of instructions, contact your nearest Customer Service Centre to obtain the necessary clarifications.

## STORING THE USE AND MAINTENANCE MANUAL

The Use and Maintenance Manual must be stored in its special pouch close to the machine, protected from liquids and anything else that could compromise its legibility.

## ON CONSIGNMENT OF THE MACHINE

When the machine is consigned to the customer, an immediate check must be performed to ensure all the material mentioned in the shipping documents has been received, and also to check the machine has not suffered damage during transportation. If this is the case, the carrier must ascertain the extent of the damage at once, informing our customer service office. It is only by prompt action of this type that the missing material can be obtained, and compensation for damage successfully claimed.

## INTRODUCTORY COMMENT

Any floor scrubbing machine can only work properly and effectively if used correctly and kept in full working order by performing the maintenance operations described in the attached documentation. We therefore suggest you read this instruction booklet carefully and read it again whenever difficulties arise while using the machine. If necessary, remember that our assistance service (organised in collaboration with our dealers) is always available for advice or direct intervention.

## IDENTIFICATION DATA

For technical assistance or to request replacement parts, always give the model, the version and the serial number (written on the relevant plate).

## TECHNICAL DESCRIPTION

The **MxL Plus** is a floor scrubbing machine that can work on various types of floor and dirt thanks to the mechanical action of a brush and the chemical action of a water-detergent solution. As it advances, it collects the dirt removed, along with the detergent solution not absorbed by the flooring itself. **The machine must only be used for this purpose.**

## INTENDED USE

This scrubbing machine was designed and built for the cleaning (scrubbing and drying) of smooth, hard flooring in the commercial, residential and industrial sectors by a qualified operator in proven safety conditions. The scrubbing machine is not suitable for cleaning rugs or carpets. It is only suitable for use in indoor (or at least covered) environments.

 **ATTENTION:** the machine is not suitable for use in the rain, or under water jets.

 **ATTENTION:** IT IS FORBIDDEN to use the machine for picking up dangerous dusts or inflammable liquids in places with an explosive atmosphere. In addition, it is not suitable as a means of transport for people or objects.

## SAFETY

Operator cooperation is paramount for accident prevention. No accident prevention programme can be effective without the full cooperation of the person directly responsible for machine operation. The majority of occupational accidents that happen either in the workplace or whilst moving are caused by failure to respect the most basic safety rules. An attentive, careful operator is most effective guarantee against accidents and is fundamental in order to implement any prevention programme.

## REGULATIONS

All references to forwards and backwards, front and rear, right and left indicated in this manual should be understood as referring to the operator in the driving position, with his/her hands on the control handlebars.

## TARGET GROUP

This manual is written both for operators and for qualified machine maintenance technicians. Operators must not perform operations that should be carried out by qualified technicians. The manufacturer is not liable for damages resulting from failure to comply with this veto.

## SERIAL NUMBER PLATE

The serial number plate is positioned underneath the electrical system control panel inside the machine. It indicates the general machine characteristics, in particular the serial number. The serial number is a very important piece of information and should always be provided together with any request for assistance or when purchasing spare parts. The serial number plate contains the following:

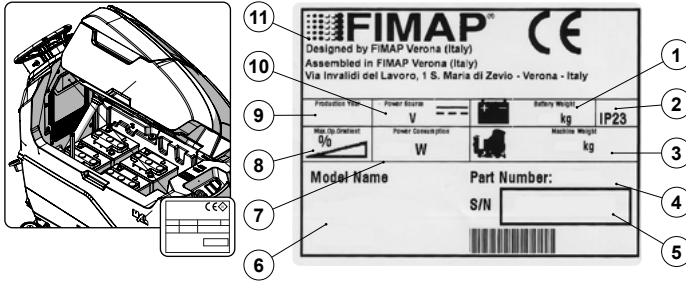

1. The maximum weight of the batteries that power the machine (expressed in kg).
2. The IP protection rating of the machine.
3. The gross weight of the machine (expressed in kg).
4. The machine ID code.
5. The machine serial number.
6. The machine ID name.
7. The nominal power consumed by the machine (expressed in W).
8. The maximum grade that the appliance can handle during work activities (expressed in %).
9. The year of machine manufacture.
10. The nominal voltage of the machine (expressed in V).
11. The commercial name of the machine, and the manufacturer's address.

## TECHNICAL DATA

TECHNICAL DATA	Unit of Measurement	MxL 65 Bt Plus	MxL 75 Bt Plus	MxL 85 Bt Plus	MxL 70 Bts Plus
Rated machine power	W	1710	1710	1710	1610
Working capacity up to <sup>(1)</sup>	m <sup>2</sup> /h	1638	1913	2100	1613
Working width	mm	655	765	840	645
Squeegee width <sup>(2)</sup>	mm	785	885	985	885
Brush head brush diameter (number - diameter)	mm	2 / Ø340	2 / Ø400	2 / Ø430	-
Dimensions of cylindrical brush [number - (diameter - length)]	mm	-	-	-	2 / (Ø180 / 616)
Number of brush head brush rotations	rpm	140	140	140	550
Brush head motor electrical properties [number / (voltage - rated power)]	V / W	2 / (24 / 500)	2 / (24 / 500)	2 / (24 / 500)	2 / (24 / 450)
Debris hopper internal volume	dm <sup>3</sup>	-	-	-	8
Weight exerted on the brush head	kg	33+45+55	35+45+57	38+45+60	15+30+40
Gradeability (weight <sup>(5)</sup> )	%	-	-	-	-
Traction motor electrical properties [number / (voltage - rated power)]	V / W	1 / (24 / 300)	1 / (24 / 300)	1 / (24 / 300)	1 / (24 / 300)
Forward speed (with transfer program active)	Km/h	4,9	4,9	4,9	4,9
Suction motor electrical properties [number / (voltage - rated power)]	V / W	1 / (24 / 422)	1 / (24 / 422)	1 / (24 / 422)	1 / (24 / 422)
Vacuum on vacuum head	mBar	112	112	112	112
Maximum solution tank capacity	l	80	80	80	80
Maximum recovery tank capacity	l	85	85	85	85
Maximum solution tank capacity	L	3	3	3	3
Machine dimensions (length - width <sup>(3)</sup> - height)	mm	1497 - 701 - 1093	1514 - 795 - 1093	1542 - 878 - 1093	1471 - 733 - 1093
Battery compartment dimensions (length - width - useful height)	mm	524 - 396 - 320	524 - 396 - 320	524 - 396 - 320	524 - 396 - 320
Electrical properties of recommended battery [number / (voltage / electric charge)]	V / AhC <sub>5</sub>	4 / (6 / 180)	4 / (6 / 180)	4 / (6 / 180)	4 / (6 / 180)
Maximum individual battery weight (recommended)	kg	31	31	31	31
Machine weight <sup>(4)</sup>	kg	191	193	196	192
Machine weight during transport <sup>(5)</sup>	kg	315	317	320	316
GVW	kg	400	402	405	410
Sound pressure level (ISO 11201) - L <sub>pa</sub>	dB (A)	<70	<70	<70	<70
Uncertainty K <sub>pa</sub>	dB (A)	1,5	1,5	1,5	1,5
Hand vibration level (ISO 5349)	m/s <sup>2</sup>	<2,5	<2,5	<2,5	<2,5
Vibration measurement uncertainty		-	-	-	-

Remarks:

- (1) The working capacity is calculated using a forward speed of 2.5 Km/h.
- (2) The width of the squeegee refers to its maximum footprint.
- (3) The width is to be understood as being without the squeegee mounted on the machine.
- (4) Machine weight: refers to the overall machine weight without the batteries, and with both tanks empty.
- (5) Machine weight during transport: refers to the overall machine weight with the batteries, but with both tanks empty.



TECHNICAL DATA	Unit of Measurement	MxL 65 Bt Plus	MxL 75 Bt Plus	MxL 85 Bt Plus	MxL 70 Bts Plus
Rated machine power	W	1710	1710	1710	1610
Working capacity up to <sup>(1)</sup>	sq. ft/h	17631	20591	22604	17362
Working width	in	25,8	30,1	33,1	25,4
Squeegee width <sup>(2)</sup>	in	30,9	34,8	38,8	34,8
Brush head brush diameter (number - diameter)	in	2 / Ø13,39	2 / Ø15,75	2 / Ø16,93	-
Dimensions of cylindrical brush [number - (diameter - length)]	in	-	-	-	2 / (Ø7,09 / 24,25)
Number of brush head brush rotations	rpm	140	140	140	550
Brush head motor electrical properties [number / (voltage - rated power)]	V / W	2 / (24 / 500)	2 / (24 / 500)	2 / (24 / 500)	2 / (24 / 450)
Debris hopper internal volume	ft <sup>3</sup>	-	-	-	0,3
Weight exerted on the brush head	lb	73+99+121	77+99+126	84+99+132	33+66+88
Gradeability (weight <sup>(5)</sup> )	%	-	-	-	-
Traction motor electrical properties [number / (voltage - rated power)]	V / W	1 / (24 / 300)	1 / (24 / 300)	1 / (24 / 300)	1 / (24 / 300)
Forward speed (with transfer program active)	mph	3	3	3	3
Suction motor electrical properties [number / (voltage - rated power)]	V / W	1 / (24 / 422)	1 / (24 / 422)	1 / (24 / 422)	1 / (24 / 422)
Vacuum on vacuum head	mBar	112	112	112	112
Maximum solution tank capacity	l	21	21	21	21
Maximum recovery tank capacity	l	22	22	22	22
Maximum solution tank capacity	l	0,8	0,8	0,8	0,8
Machine dimensions (length - width <sup>(3)</sup> - height)	in	59 - 28 - 43	60 - 31 - 43	61 - 35 - 43	58 - 29 - 43
Battery compartment dimensions (length - width - useful height)	in	20,6 - 15,6 - 12,6	20,6 - 15,6 - 12,6	20,6 - 15,6 - 12,6	20,6 - 15,6 - 12,6
Electrical properties of recommended battery [number / (voltage / electric charge)]	V / AhC <sub>5</sub>	4 / (6 / 180)	4 / (6 / 180)	4 / (6 / 180)	4 / (6 / 180)
Maximum individual battery weight (recommended)	lb	68	68	68	68
Machine weight <sup>(4)</sup>	lb	421	426	432	423
Machine weight during transport <sup>(5)</sup>	lb	694	699	706	697
GVW	lb	882	886	893	904
Sound pressure level (ISO 11201) - L <sub>pa</sub>	dB (A)	<70	<70	<70	<70
Uncertainty K <sub>pa</sub>	dB (A)	1,5	1,5	1,5	1,5
Hand vibration level (ISO 5349)	m/s <sup>2</sup>	<2,5	<2,5	<2,5	<2,5
Vibration measurement uncertainty		-	-	-	-

Remarks:

- (1) The working capacity is calculated using a forward speed of 1.5 Km/h.
- (2) The width of the squeegee refers to its maximum footprint.
- (3) The width is to be understood as being without the squeegee mounted on the machine.
- (4) Machine weight: refers to the overall machine weight without the batteries, and with both tanks empty.
- (5) Machine weight during transport: refers to the overall machine weight with the batteries, but with both tanks empty.

## DISPOSAL

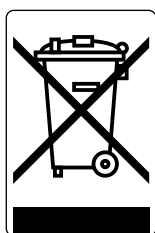



To dispose of the machine, take it to a demolition centre or an authorised collection centre. Before scrapping the machine, it is necessary to remove and separate out the following materials, then send them to the appropriate collection centres in accordance with the environmental hygiene regulations currently in force:

- Brushes
- Felt
- Electric and electronic parts\*
- Batteries
- Plastic parts (tanks and handlebars)
- Metal parts (levers and frame)







(\* ) In particular, contact your distributor when scrapping electric and electronic parts.

## SYMBOLS USED ON THE MACHINE









### SYMBOLS PRESENT ON THE REGISTRATION PLATE

	<b>Direct current symbol:</b> Used on the machine's registration plate to indicate that it is powered by a DC power supply.
	<b>Battery symbol:</b> Used on the machine's registration plate to indicate the maximum weight of the batteries used to power the machine (expressed in kg). The value refers to the batteries that the manufacturer offers.
	<b>Maximum gradient symbol:</b> Used on the machine serial number plate, to indicate the maximum gradient that can be safely handled in working mode.

### SYMBOLS PRINTED ON THE MACHINE

	<b>Solution tank drain pipe symbol:</b> Located on the rear part of the machine, to identify the solution tank drainage point.
	<b>Recovery tank drainage hose symbol:</b> Located on the rear part of the machine, to identify the recovery tank drainage tube.
	<b>Cap/filter position symbol:</b> Located on the right-hand side of the machine to indicate the position of the detergent solution tank filter-cap.
	<b>Symbol of maximum temperature for filling the solution tank:</b> Located on the front of the machine to indicate the maximum temperature of the water for filling the solution tank safely.
	<b>Squeegee body working position symbol:</b> Located on the rear part of the machine, to indicate the squeegee control lever rotation direction for bringing the squeegee to its working position.
	<b>Symbol for squeegee body idle:</b> Located on the rear part of the machine, to indicate the squeegee control lever rotation direction for bringing the squeegee to its idle position.
	<b>Battery connection symbol:</b> Located on the front of the solution tank, to indicate how to connect the batteries in order to obtain a total voltage of 24V.

### LABELS USED ON THE MACHINE

	<b>Label for detergent solution tap command:</b> Located on the right-hand side of the machine, to identify the control knob of the detergent solution tap.
	<b>Label for brush head tilt adjustment:</b> Located on the front of the machine, to identify the knob for adjusting the brush head body tilt.
	<b>Label indicating the need to read the Use and Maintenance Manual:</b> Affixed to the machine in order to warn the operator to read the user and maintenance manual (this document) before using the machine for the first time.
	<b>Battery recharge hazard label:</b> Located inside the machine (above the electric system carter), to warn the operator of the possible risk during battery recharging
	<b>Battery recharge warning label:</b> Located inside the machine (above the electric system carter), to warn the operator when it's necessary to recharge the batteries.
	<b>Daily care warning label:</b> Applied to the machine to remind the operator of the applicable procedures for properly caring for the machine itself.
	<b>Machine use warning label:</b> Located on the rear of the machine, to warn the operator which substances cannot be removed with the machine.
	<b>Solution tank filter daily care warning label:</b> Applied to the machine to remind the operator to clean the solution tank after each use.



**Moving brush hazard label:**

Used on the machine to warn the operator not to place his/her hands near the moving brush.



**Label warning about the risk of crushed hands:**

Indicates danger to hands due to crushing between two surfaces.



**Main switch symbol:**

Located near the control panel, to indicate the main key switch.

## TOUCH SCREEN DISPLAY

### CONTROL SCREEN



The control screen is divided in:

1. Information field.
2. Drive Select selector.
3. ECO program button.
4. Performance level indicators.
5. Brush uncoupling button.
6. Menu button.
7. Text indicator.
8. Zone Program button.

### INFORMATION FIELD

The information field is divided into:

1. Fimap Fleet Management active symbol.
2. Fimap Solution Saver active or Fimap Long Range active symbol.
3. Working headlights active symbol.
4. Hour meter.
5. Battery charge level.
6. Error symbol.
7. Symbol denoting full recovery tank.
8. Symbol denoting empty solution tank.



## PREPARATION OF MACHINE

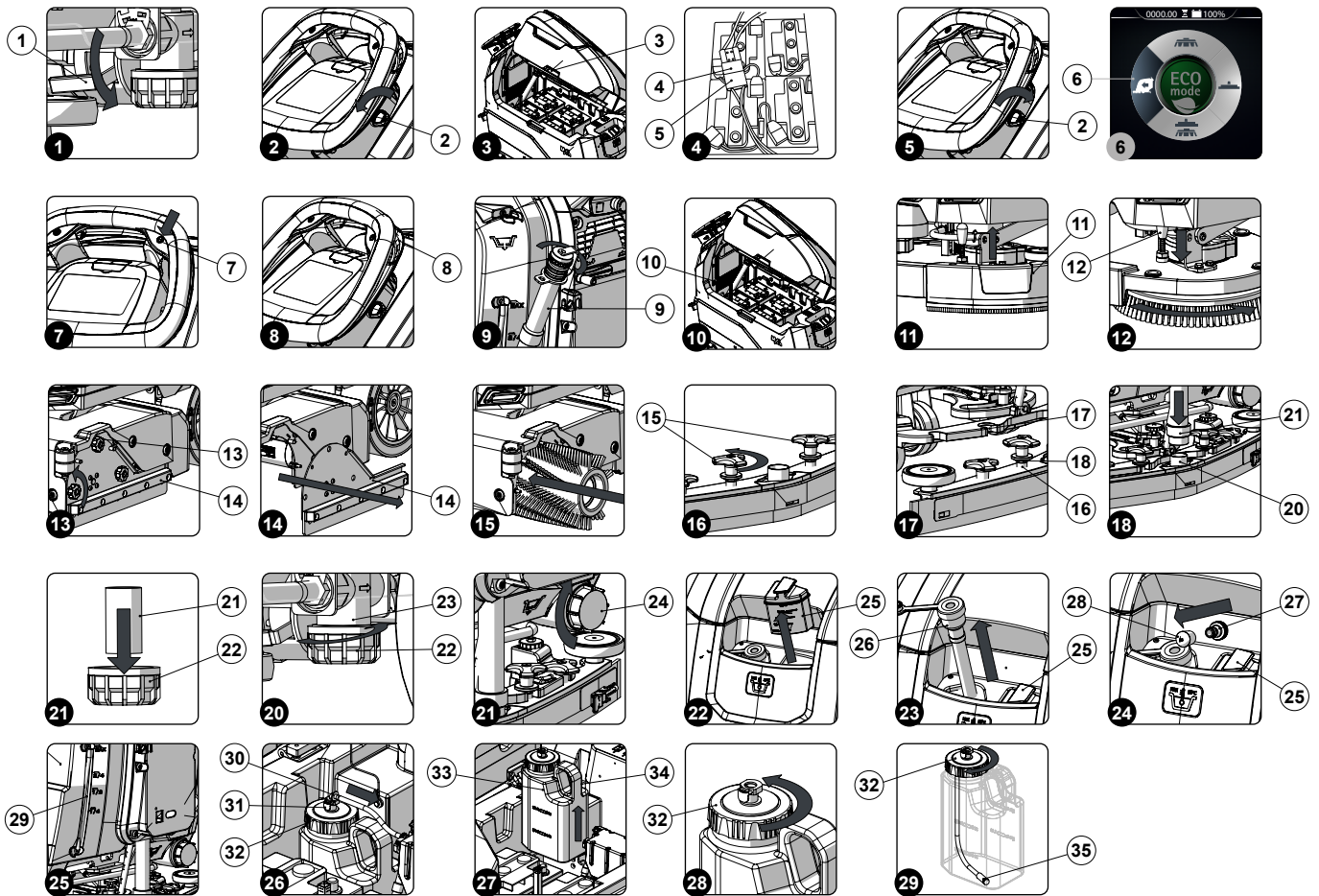

### HANDLING THE PACKAGED MACHINE

The machine is contained in specific packaging, and since the packaging elements (plastic bags, staples, etc.) are a potential source of danger, they should not be left within the reach of children, disabled persons, etc.

The machine's overall weight including packaging is 000Kg.

The overall dimensions of the package are: width=765mm length=1460mm height=1270mm.

**i** **N.B.:** it is recommended that all the packaging components be kept for any future machine transportation.

**⚠** **ATTENTION:** Move the packaged product with handling equipment that complies with legal requirements regarding size and mass of the packaging.

### HOW TO UNPACK THE MACHINE

The machine is shipped in specific packaging. To remove it, proceed as follows:

1. Place the lower part of the outer packaging in contact with the floor.

**i** **N.B.:** Use the pictograms printed on the box as reference.

2. Remove the outer package.

**⚠** **CAUTION:** these operations must be carried out using protective gloves to avoid any possible contact with the edges or tips of metal objects.

3. Make sure the electric brake is engaged, then rotate the lever (1) in the direction of the arrow. The lever is located on the rear right-hand side of the machine (Fig.1).
4. Check that the machine is off; if this is not the case, set the main switch to position "0" by turning the key (2) a quarter turn anti-clockwise (Fig.2). Remove the key from the instrument panel.
5. Grip the handle (3) on the right-hand side of the recovery tank and turn the tank as far as it will go, until it reaches the maintenance position (Fig.3).
6. Connect the battery hopper connector (4) to the connector of the general system (5) (Fig. 4).

**⚠** **CAUTION:** This process must be carried out by qualified personnel.

7. Grip the handle (3) and turn the recovery tank until it reaches the working position.
8. The machine is fixed to the pallet by means of chocks, which block the wheels and brush head; remove these chocks.
9. Insert the starter key and turn on the machine; turn the main switch to the "I" position by turning the key (2) a quarter turn clockwise (Fig.5).
10. Using the DS selector on the control display (Fig.6), select the "transfer" program (6).

 **N.B.:** in this working program both the brush head and the squeegee support will be in the resting position (raised from the floor).

 **N.B.:** in the DS selector, the transport program symbol (6) is green (Fig.6).

 **N.B.:** the grey symbols show working programs that are not active. the green symbols show working programs that are active.

11. Press the "REVERSE ACTIVATION - DEACTIVATION" button (7) on the control handlebars (Fig.7).
12. Activate the dead man's lever (8) underneath the control handlebars (Fig.8) to start moving the machine in reverse.
13. Use a ramp to bring the machine down from the pallet.

 **CAUTION:** do not fit the brush and the rear squeegee body before unloading the machine, and avoid any violent jolts to the brush head and squeegee support.

 **N.B.:** the ramp gradient must not be such as to cause damage to the machine as it comes down.

14. Turn off the machine and turn the key (2) a quarter turn anticlockwise (Fig.2). Remove the key from the instrument panel.
15. Grip the handle (3) and turn the recovery tank as far as it will go to the maintenance position (Fig.3).
16. Disconnect the pad battery connector (4) from the main system connector (5) (Fig.4).

 **ATTENTION:** This process must be carried out by qualified personnel.

17. Grip the handle (3) on the right-hand side of the recovery tank and turn the tank until it reaches the work position.

## HOW TO MOVE THE MACHINE

To transport the machine safely, proceed as follows:

 **DANGER:** before starting any task, make sure the current regulations concerning the safe transport of dangerous substances are scrupulously observed.

1. Check to make sure that the solution tank and the recovery tank are empty. If this is not the case, empty them (see the sections titled "EMPTYING THE SOLUTION TANK" and "EMPTYING THE RECOVERY TANK").
2. Insert the key (2) into the main switch on the control panel. Bring the main switch to the "I" position by turning the key (2) a quarter turn clockwise (Fig.5).
3. Using the DS selector on the control display (Fig.6), select the "transfer" program (6).
4. When you push the dead man's lever (8) (Fig.8), the machine will begin to move.
5. Use a ramp to move the machine up onto the transport vehicle.

 **CAUTION:** During this operation, check there are no people or objects near the machine.

 **N.B.:** the ramp gradient must not be such as to cause damage to the machine as it goes up.

6. Position the machine on the means of transport, and set the main switch to the "0" position by turning the key (2) a quarter turn anticlockwise (Fig.2). Remove the key from the main switch.
7. Grip the handle (3) and raise the recovery tank to the maintenance position (Fig.3).
8. Disconnect the battery connector (4) from the main system connector of the machine (5) (Fig.4).
9. Grip the handle (3) and lower the recovery tank to its working position.

 **WARNING:** secure the device according to the directives in force in the country of use, so that it cannot slide or tip over.

## MACHINE SAFETY

To ensure that work is carried out in the best safety conditions, proceed as follows:

1. Make sure the electric brake is engaged, then rotate the lever (1) in the direction of the arrow. The lever is located on the rear right-hand side of the machine (Fig.1).
2. Make sure the recovery tank is empty. If this is not the case, empty it using the tube (9) on the rear left-hand side of the machine (Fig.9) (see "EMPTYING THE RECOVERY TANK").
3. Insert the key (2) into the main switch on the control panel. Bring the main switch to the "I" position by turning the key (2) a quarter turn clockwise (Fig.5).
4. Using the DS selector on the control display (Fig.6), select the "transfer" program (6).
5. Turn off the machine and turn the key (2) a quarter turn anticlockwise (Fig.2). Remove the key from the instrument panel.
6. Grip the handle (3) on the right-hand side of the recovery tank (Fig.3) and turn the tank as far as it will go, until it reaches the maintenance position.

7. Disconnect the battery connector (4) from the main system connector of the machine (5) (**Fig.4**).

 **ATTENTION:** This process must be carried out by qualified personnel.

8. Grip the handle (3) on the right-hand side of the recovery tank and turn the tank until it reaches the work position.

### TYPE OF BATTERY TO BE USED

Power to the machine must be supplied by two sealed traction batteries with gas recombination or gel technology. The batteries must meet the requirements laid out in the norms: CEI EN 60254-1:2005-12 (CEI 21-5) + CEI EN 60254-2:2008-06 (CEI 21-7). In order to ensure good operating performance, it is recommended to use four 6V MFP 180 Ah/C5 batteries.

### BATTERY MAINTENANCE AND DISPOSAL

For battery maintenance and recharging, respect the instructions provided by the battery manufacturer. When the batteries reach the end of their service life, they must be disconnected by specialized and properly trained personnel, and must be subsequently removed from the battery compartment using suitable lifting devices.



N.B.: dead batteries are classified as dangerous waste and as such must be delivered to an authorised body for disposal.

### INSERTING THE BATTERIES IN THE MACHINE

To fit the batteries inside the machine, contact an FIMAP assistance centre technician.  
The batteries should be connected so as to obtain a total voltage of 24V.

 **WARNING:** FIMAP declines all responsibility for any damage to property or injury persons in the event that the batteries are replaced by an unauthorized technician.

### RECHARGING THE BATTERIES

The batteries must be charged prior to first use, and whenever they no longer provide sufficient power.

 **ATTENTION:** to avoid any permanent damage to the batteries, it is essential to avoid their complete discharge; begin recharging them within a few minutes of noting the "discharged batteries" signal.

 **ATTENTION:** never leave the batteries completely discharged, even if the device is not being used.

1. Bring the machine to the battery recharging area.
2. Make sure the machine is in a safe condition (read "[SECURING THE MACHINE](#)").



**ATTENTION:** Park the machine in an enclosed place, on a flat and level surface; near the machine there must be no objects that could either damage it, or be damaged through contact with it.



**ATTENTION:** the room used to recharge the batteries must be adequately ventilated to prevent the accumulation of gases that leak from batteries.

3. Grip the handle (3) and raise the recovery tank to the maintenance position (**Fig.3**).

**To recharge the batteries without the built-in battery charger, proceed as follows:**

 **ATTENTION:** the following operations must be carried out by qualified personnel. An incorrect connection of the connector may cause problems with machine functioning.

- Connect the external battery charger cable to the battery connector.



**NOTE:** the coupling connector of the battery charger is consigned inside the bag containing this instruction booklet, and must be assembled on the cables of the battery charger as indicated in the instructions.



**ATTENTION:** Before connecting the batteries to the battery charger, make sure that this is suitable for the batteries being used.



**NOTE:** Carefully read the Use and Maintenance Manual of the battery charger to be used before carrying out the battery charge cycle.

- Grasp the handle (3) and turn to the charging position; the lower part of the recovery tank must be resting on the stop (10) (**Fig.10**).





**CAUTION:** keep the recovery tank open for the duration of the battery recharging cycle to allow gas fumes to escape.

- Once the recharge cycle has been completed, disconnect the battery charger's cable from the battery connector.
- Connect the electrical system connector to the battery connector.
- Grip the handle (3) and turn the recovery tank to its working position.

To recharge the batteries with the on-board battery charger proceed as follows:

 **ATTENTION:** the following operations must be carried out by qualified personnel. An incorrect connection of the connector may cause problems with machine functioning.

 **NOTE:** Carefully read the Use and Maintenance Manual of the battery charger delivered with the machine before carrying out the battery charge cycle.

 **CAUTION:** before connecting the batteries to the battery charger, make sure it is suitable for the batteries used.

 **NOTE:** The charger power cable is delivered inside the bag containing this instruction booklet.

- Connect the battery charger power supply cable to the cable on the battery charger itself.
- Plug the battery charger cable into the mains socket.
- Grasp the handle (3) and turn to the charging position; the lower part of the recovery tank must be resting on the stop (10) (**Fig.10**).

 **CAUTION:** keep the recovery tank open for the duration of the battery recharging cycle to allow gas fumes to escape.

- When the recharge cycle is complete, disconnect the battery charger power supply cable from the mains.
- Disconnect the battery charger power supply cable from the cable on the battery charger itself.
- Grip the handle (3) and turn the recovery tank to its working position.

### ASSEMBLING THE BRUSH (SCRUBBING VERSION)

To assemble the brushes to bush head body, which for reasons of packaging are supplied dismantled from the machine, proceed as follows:

1. Make sure the machine is in a safe condition (read "[SECURING THE MACHINE](#)").

 **CAUTION:** users are advised to always wear protective gloves, to avoid the risk of serious injury to hands.

2. With the brush head in the raised position, remove the brush head splash guards (11) (**Fig.11**).
3. Insert the brush into the flange on the brush head body, press the brush-holder plate retainer (12) and simultaneously rotate the brush in the direction shown in the image (**Fig.12**).

 **ATTENTION:** **Fig.12** shows the rotation direction of the left-hand brush, rotate in the opposite direction for the right-hand brush.

4. Repeat the operations completed for the right-hand front brush as well.

### ASSEMBLING THE BRUSH (SWEEPING VERSION)

To assemble the brushes to bush head body, which for reasons of packaging are supplied dismantled from the machine, proceed as follows:

1. Perform the procedure for securing the machine ( see the section titled "[SECURING THE MACHINE](#)").

 **CAUTION:** users are advised to always wear protective gloves, to avoid the risk of serious injury to hands.

2. With the brush head raised from the floor, turn the knobs (13) that hold the left lateral carter (14) in place anti-clockwise (**Fig.13**).
3. Remove the left lateral carter (14) (**Fig.14**).
4. Insert the brush into the tunnel (**Fig.15**), taking care to ensure that the gearmotor shaft enters the slit in the brush itself.
5. Repeat the previously described operations for the right-hand side as well.

 **N.B.:** In order to be installed correctly, the brushes must form an X when viewed from above in the forward direction of movement.

### ASSEMBLING THE SQUEEGEE BODY

For packaging reasons, the squeegee body comes disassembled from the machine. In order to mount it on the squeegee support, do the following:

1. Make sure the machine is in a safe condition (read "[SECURING THE MACHINE](#)").

 **CAUTION:** these operations must be carried out using protective gloves to avoid any possible contact with the edges or tips of metal objects.

2. Unscrew the knobs (15) in the squeegee body pre-assembly (**Fig.16**).
3. First of all, insert the left-hand pin (16) on the squeegee body in the left slit (17) in the squeegee support (**Fig.17**), so that the bushing (18) adheres to the walls of the slit in the squeegee support.
4. Repeat the same operation for the right pin.
5. Tighten the knobs (15) to fix the squeegee body to the support.
6. Insert the vacuum tube (21) in the sleeve (20) on the squeegee body (**Fig.18**).

 **N.B.:** the tube must be positioned behind the squeegee lifting chain.

 **N.B.:** Although the squeegee comes pre-adjusted, it is nevertheless recommended to read the section entitled [“ADJUSTING THE SQUEEGEE BODY RUBBER BLADES”](#).

### INSERTING WATER SYSTEM FILTER

Before using the machine for the first time the water system filter needs to be reset, for shipping reasons the filter cartridge and the cap have been removed. To insert the filter cartridge in the water system filter body proceed as follows:

1. Take the machine to the maintenance area.
2. Make sure the machine has been secured (see the section titled [“SECURING THE MACHINE”](#)).

 **CAUTION:** users are advised to always wear protective gloves, to avoid the risk of serious injury to hands.

3. Insert the filter cartridge (21) in the housing on the cap (22) (**Fig.21**).

 **N.B.:** The O-ring gasket in the filter cartridge should be inserted into its seat in the cap.

4. Go to the right-hand side of the machine and screw the cap (22) onto the body of the detergent solution filter (23) (**Fig.20**).

### FILLING THE SOLUTION TANK WITH WATER

Before filling the solution tank, carry out the following steps:

1. Take the machine to the usual place for filling the solution tank.
2. Perform the procedure for securing the machine ( see the section titled [“SECURING THE MACHINE”](#)).
3. Check the solution tank drainage cap (24) (on the rear right-hand side of the machine) is tight. If this is not the case, turn it clockwise (**Fig.21**).
4. Check the water system filter cap (22) (on the rear right-hand side of the machine) is tight. If this is not the case, turn it clockwise (**Fig.20**).

The solution tank can be filled with water in three different ways:

- Remove the cap-measuring device (25) (**Fig. 22**) and fill the solution tank by means of a rubber hose or a bucket.
  - Using the filler hose (26) (**Fig.23**), which supports the water hose on its own, be sure to remove the cap-measuring device (25) in order to allow the air to vent properly.
  - Using the optional automatic clean water refill system, connect the female connector on the tube to the male connector (27) on the machine (**Fig. 24**); before connecting the tube, remember to remove the cap (28) and the cap-measuring device (25) to enable the air to be vented.
5. Fill with clean water, at a temperature not higher than 50°C and not lower than 10°C. The amount inside the tank can be seen by means of the level tube (29) (**Fig.25**) on the rear of the machine.

### DETERGENT SOLUTION (VERSIONS WITHOUT FSS)

After filling the solution tank with clean water add the liquid detergent to the tank in the concentration and manner indicated on the detergent manufacturer's label. To prevent the formation of an excessive amount of foam that could damage the vacuum motor, use the minimum percentage of detergent required.

 **CAUTION:** protective gloves should always be worn before handling detergents or acidic or alkaline solutions, to avoid serious injury to the hands.

 **CAUTION:** Always use detergents which have a manufacturer's label that indicates that they are suitable for use with floor scrubbing machines. Do not use acid or alkaline products or solvents without this indication.

 **ATTENTION:** Acid or alkaline maintenance detergent can be used with pH values between 4 and 10 and that do not contain: oxidising agents, chlorine or bromine, formaldehyde, mineral solvents. The detergents used must be suitable for use with scrubbing machines.

 **CAUTION:** always use low-foam detergent. To avoid the production of foam, put a minimum quantity of antifoam liquid in the recovery tank before starting to clean. Do not use pure acids.

 **N.B.:** to make it easier to measure the detergent on the cap/measuring device, there are notches indicating the detergent percentage quantities that can be used. The notches range from a minimum of 0.1% to a maximum of 0.5%.

### FILLING THE DETERGENT CANISTER (VERSIONS WITH FSS)

After filling the solution tank with clean water, you must fill the detergent canister. Before filling the canister, carry out the following steps:

1. Take the machine to the usual place for filling the solution tank.
2. Perform the procedure for securing the machine ( see the section titled [“SECURING THE MACHINE”](#)).
3. Grip the handle (3) on the right-hand side of the recovery tank (**Fig.3**) and turn the tank as far as it will go, until it reaches the maintenance position.



4. Disconnect the male insert (30) from the female insert (31) in the cap (32) of the detergent canister (33) (**Fig.26**).

**i** **ATTENTION:** before pulling on the male insert, push the lever on the female insert.

5. Gripping the handle (34) on the detergent canister (33), remove the canister from the compartment in the solution tank (**Fig.27**).

6. Remove the cap (32) from the detergent canister (**Fig.28**).

7. Fill the canister with the required detergent, as indicated on the label supplied with the machine.

**!** **CAUTION:** protective gloves should always be worn before handling detergents or acidic or alkaline solutions, to avoid serious injury to the hands.

**!** **WARNING:** always use low-foam detergent. To avoid the production of foam, put a minimum quantity of antifoam liquid in the recovery tank before starting to clean. Do not use pure acids.

**!** **WARNING:** Always use detergents which have a manufacturer's label that indicates that they are suitable for use with floor scrubbing machines. Do not use acid or alkaline products or solvents without this indication.

**i** **ATTENTION:** the dosing system is suitable for frequent maintenance cleaning. Acid or alkaline maintenance detergent can be used with pH values between 4 and 10 and that do not contain: oxidising agents, chlorine or bromine, formaldehyde, mineral solvents. The detergents used must be suitable for use with scrubbing machines. Wash the circuit with water after use if the system is not used daily. The system can be excluded. In case of sporadic use of detergents with pH between 1-3 or 11-14, use the floor scrubbing machine in the traditional way by adding the detergent in the clean water tank and excluding the dosing circuit.

8. Ensure that you tighten the cap (32) properly to avoid any leakage of liquid while working. Make sure the detergent suction filter (35) is correctly positioned on the bottom of the canister (**Fig.29**).

9. Grip the canister handle (34) to replace the canister (33) in its compartment inside the solution tank.

10. Connect the male insert (30) to the female insert (31) in the cap (32) of the detergent canister (33).

11. Grip the handle (3) on the right-hand side of the recovery tank and turn the tank as far as it will go, until it reaches the work position.

## PREPARING TO WORK

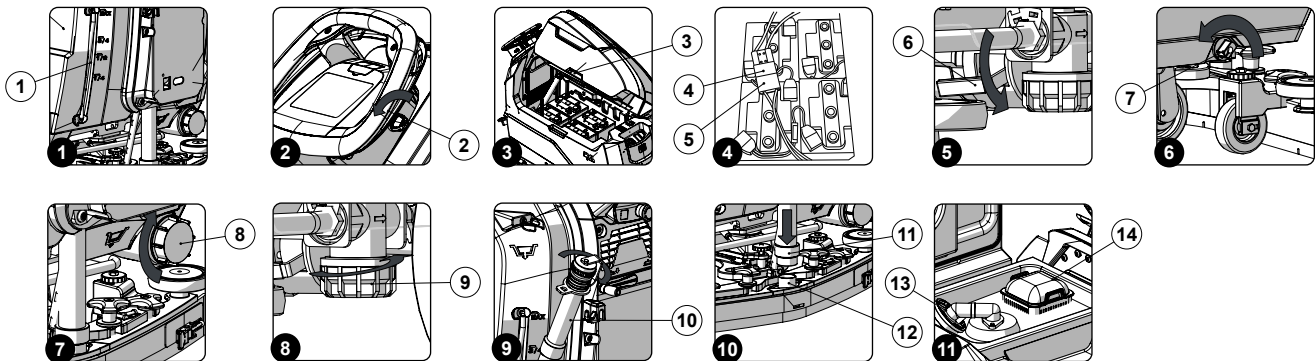

Before beginning to work, it is necessary to:

1. Make sure the recovery tank is empty. If this is not the case, empty it (read "[EMPTYING THE RECOVERY TANK](#)").
2. Check that the quantity of detergent solution present in the solution tank is suitable for the type of work to be carried out. If this is not the case, fill the solution tank (see "[THE SOLUTION TANK WITH WATER](#)" and "[DETERGENT SOLUTION \(VERSIONS WITHOUT FSS\)](#)" or "[FILLING THE DETERGENT CANISTER \(VERSIONS WITH FSS\)](#)"). Check the level tube (1) in the rear left-hand part of the machine (**Fig.1**).
3. Check the rubber squeegee blades are in good working condition. If they aren't, replace them (see "[REPLACING THE SQUEEGEE BODY RUBBER BLADES](#)").
4. Check that the condition of the brush is suitable for work; if this is not the case, replace it (see "[REPLACING THE BRUSH HEAD BRUSH \(SCRUBBING VERSION\)](#)" or "[REPLACING THE BRUSH HEAD BRUSH \(SWEEPING VERSION\)](#)").
5. Check that the machine is off; if this is not the case, turn the key (2) a quarter turn anti-clockwise (**Fig.2**). Remove the key from the instrument panel.
6. Grip the handle (3) on the right-hand side of the recovery tank (**Fig.3**) and turn the tank as far as it will go, until it reaches the maintenance position.
7. Connect the main system connector (4) to the battery connector (5) (**Fig.4**).

**!** **ATTENTION:** This process must be carried out by qualified personnel.

8. Grip the handle (3) on the right-hand side of the recovery tank and turn the tank until it reaches the work position.

9. Make sure the electronic brake is engaged. If this is not the case, turn the lever (6) in the direction of the arrow. The traction gearmotor is located on the right-hand side of the machine (**Fig.5**).

10. Check the water tap is fully open - the water adjustment knob (7) must be turned fully in the direction shown by the arrow (**Fig.6**).
11. Make sure the solution tank drainage cap (8) is closed. If it isn't, close it (**Fig.7**).
12. Make sure the water filter cap (9) is closed. If it isn't, close it (**Fig.8**).
13. Make sure the cap of the recovery tank drainage tube (10) is closed. If it isn't, close it (**Fig.9**).
14. Make sure the vacuum tube (11) is correctly connected to the sleeve (12) in the squeegee body. If it isn't, connect it (**Fig.10**).
15. Make sure the suction motor filter (13) is correctly connected and is clean (**Fig.11**). If it isn't, clean it (see "[CLEANING THE RECOVERY TANK FILTERS](#)").
16. Make sure the filter basin (14) is correctly connected and is clean (**Fig.11**). If it isn't, clean it (see "[CLEANING THE RECOVERY TANK FILTERS](#)").

## STARTING WORK

The machine can be used in the following work modes:

- ECO-MODE, read the section "ECO-MODE";
- MANUAL MODE, read the section "MANUAL MODE";
- PROGRAM ZONE, read the section "PROGRAM ZONE MODE".

As an example, we will look at the program mode. To begin working in this mode, proceed as follows:

1. Make all the checks listed in "PREPARING TO WORK".
2. Sit on the driver's seat.
3. Insert the key (1) into the main switch on the control panel. Set the main switch to "I" (**Fig.1**).
4. The first and second screen displayed allow you to check the software versions of the functions board and the display board.
5. A few seconds after ignition, the password screen is displayed (**Fig.2**).
6. Enter the password and press the enter key (2) (**Fig. 2**).

 **N.B.:** to delete a wrong entry press the delete key (3) (**Fig. 2**).

 **N.B.:** the password entered by the manufacturer is 1000.

 **N.B.:** it is possible to disable the password entry function; refer to the programming manual that is provided with the machine.

 **N.B.:** to find out the password to enter, contact the nearest assistance centre.

7. If the password is correct you pass to the "MAIN" screen (**Fig.3**).

 **N.B.:** by default the machine is set to the transfer program (**Fig.3**).

8. Select the desired working program with the DS selector device (see "DS (DRIVE SELECT) SELECTOR").
9. Select the required work area and press the "ZONE" key (see "ZONE PROGRAM MODE").
10. When you push the dead man's lever (4) (**Fig.4**), the machine will begin to move.

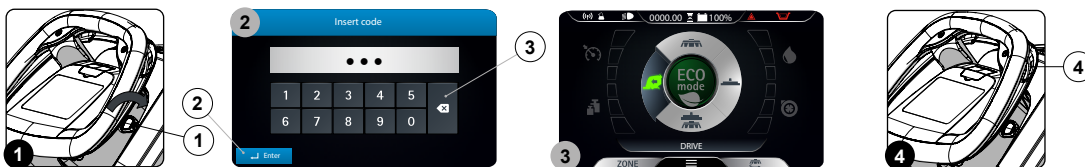

If the program selected is "SCRUBBING WITH DRYING", the squeegee and brush head will lower until they touch the floor.

As soon as the drive pedal is pressed, the traction motor, brush head motor and suction motor will start working. As a result, the solenoid valve will also be activated and detergent solution will be dispensed onto the brushes.

During the first few metres, check that there is sufficient solution and that the squeegee is drying correctly.

The machine will now begin to work with full efficiency until the battery is flat or until the detergent solution has finished.

## HOUR METER



The control display is in the control panel, at the top in the middle it is possible to observe the total time the machine has been used.  
 The digits that precede the "." symbol identify hours, whilst the digit that follows it indicates hour decimals (an hour decimal corresponds to six minutes).  
 When the "hour glass" symbol (1) is flashing it indicates that the hour meter is counting the appliance's operating time.

## BATTERY CHARGE LEVEL INDICATOR

The control display is in the control panel, at the top in the middle it is possible to observe the charge level of the batteries.  
 The indicator is composed of two charge level symbols, the first represented by a graphic symbol (2), the second by a number that indicated the charge percentage (3).

With a low charge level the graphic symbol (2) will start to flash and after a few seconds it will switch off, in these conditions take the machine to the place where its batteries can be charged.

- i** **N.B.:** a few seconds after the battery charge reaches the critical level, the brush gear motors switch off automatically. With the remaining charge it is possible to complete the drying process before starting the recharge.
- i** **N.B.:** A few seconds after the battery charge reaches the discharge level, the suction motor switches off automatically.

## DS SELECTOR (DRIVE SELECT)

Using the DS selector it is possible to select one of the following working programs:

- A. Transfer: movement of the machine without working.
- B. Scrubbing only : using only the brushes in the brush head.
- C. Drying: using the squeegee only.
- D. Scrubbing with Drying: using both the brushes and the squeegee.

Pressing one of the symbols in the selector will shift from the working screen (Fig.1) to the "DRIVE SELECT" screen (Fig.2).  
 On this screen it is possible to:

1. Confirm the selected program.

- i** **N.B.:** to confirm the program press the icon just selected once again.
- i** **N.B.:** once the selection is confirmed you return to the working screen (Fig.1).

2. Cancel the selection and return to the working screen

- i** **N.B.:** to cancel the selection press the "back" button (1) (Fig.2) and you return to the working screen without changing the program being used.
- i** **N.B.:** to cancel the selection wait 5 seconds without selecting anything and you will return to the working screen without changing the program being used.

3. Select a mode other than the one highlighted.

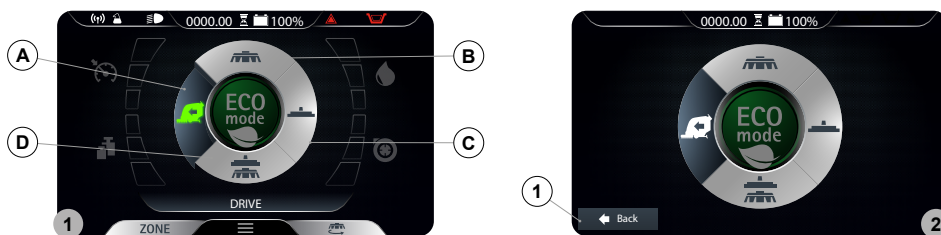

**⚠ ATTENTION:** if you want to pass from a work program with the washing mode (only washing or washing with drying) to the transfer program always remember to select the vacuum program for the time needed to collect the detergent solution on the ground.

**TRANSFER**

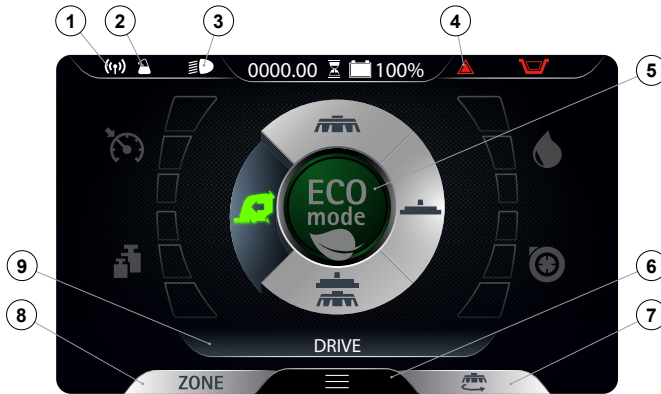

By selecting the "TRANSFER" program, the command display screen will appear as in the adjacent figure.

- i** **N.B.:** with this working program both the brush head and the squeegee support are put in the rest position (raised off the floor) and the motors switch off with the respective switching off delays (even if the drive pedal is not pressed). When the drive pedal is pressed only the traction motor is powered.
- i** **N.B.:** In the DS selector, the transport program symbol (A) is green (read the paragraph "DS (DRIVE SELECT) SELECTOR").
- i** **N.B.:** the grey symbols show working programs that are not active. the green symbols show working programs that are active.

The icons that may be visible on the control panel display are:

1. FFM symbol, if visible it shows that the system is operating.
2. FSS symbol, if visible it shows that the system is operating.
3. Working lights symbol, if visible it shows that the working lights are on.
4. General alarm symbol.

**⚠ ATTENTION:** if visible stop the machine, to continue working (read the paragraph "ALARM SCREEN").

5. Eco-Mode button.

**i** **N.B.:** if the Eco-Mode button (8) is pressed in the transfer mode the scrubbing with drying program is started in economic mode.

6. Menu button.
7. Rear view camera button.

**i** **N.B.:** pressing the rear view camera button (7) if present the video camera on the back of the machine will start, read the section "REAR VIEW VIDEO CAMERA (OPTIONAL)" to continue working.

8. Zone button.

**i** **N.B.:** if the Zone button (8) is pressed in transfer mode, the window for selecting the zone opens (read the section "ZONE PROGRAM MODE"); after selecting a zone, the machine shifts into scrubbing with drying mode with the program of the zone selected.

9. Text indicator.

**i** **N.B.:** in the text indicator (9) it is possible to see that the zone program has been selected or whether you are in transport mode if there is the word "DRIVE".

**i** **N.B.:** If you need to activate the dipped headlights during the transfer, read the section "WORKING LIGHTS".

**SCRUBBING WITHOUT DRYING**



By selecting the "SCRUBBING WITHOUT DRYING" program, the command display screen will appear as in the adjacent figure.

- i** **N.B.:** with this working program pressure on the drive pedal only brings the brush heads to the work position (in contact with the floor), while the squeegee remains in the rest position (raised from the floor). The brush head solenoid valve and the water system pump are powered up (only if the detergent solution is other than zero). When the drive pedal is pressed the brush heads, the solenoid valve, the electric pump and the traction motor are powered up.

- i** **N.B.:** In the DS selector, the scrubbing without drying program symbol (B) is green (read the paragraph “DS (DRIVE SELECT) SELECTOR”).
- i** **N.B.:** the grey symbols show working programs that are not active. the green symbols show working programs that are active.
- i** **N.B.:** when the drive pedal is released all the brush head motors stop with the respective delays. After the “Reset Delay”time all the brush heads are taken to the rest position (raised off the floor). by pressing the forward movement pedal it will start working with the same program and with the same parameters that were set before it stopped.
- i** **N.B.:** if you reverse with this program active the brush head will remain in contact with the floor, the motor will continue working but the solenoid valve will not deliver the detergent solution to the brushes.

The icons that may be visible on the control panel display are:

1. FFM symbol, if visible it shows that the system is operating.
2. FSS symbol, if visible it shows that the system is operating.
3. Working lights symbol, if visible it shows that the working lights are on.
4. General alarm symbol.

**⚠ ATTENTION:** if visible stop the machine, to continue working (read the paragraph “ALARM SCREEN”).

5. Eco-Mode button.

**i** **N.B.:** if you press the Eco-Mode button (8) you start the working program currently in use in economic mode, to remove the economic mode read the section “ECO MODE”.

6. Menu button.
7. Rear view camera button.

**i** **N.B.:** pressing the rear view camera button (7) if present the video camera on the back of the machine will start, read the section “REAR VIEW VIDEO CAMERA (OPTIONAL)” to continue working.

8. Zone button

**i** **N.B.:** if you need to change the program used when working, press the Zone button (8) (read the section “ZONE PROGRAM MODE”).

9. Text indicator.

**i** **N.B.:** in the text indicator (9) it is possible to see that the zone program has been selected or whether you are in transport mode if there is the word “DRIVE”.

**i** **N.B.:** If you need to activate the dipped headlights when working, read the section “WORKING LIGHTS”.

**⚠ ATTENTION:** never switch off the machine while the squeegee and/or brush head is in contact with the floor

## DRYING

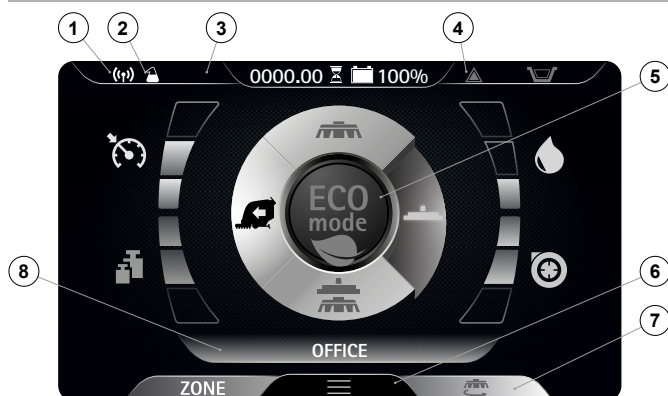

By selecting the “DRYING” program, the command display screen will appear as in the adjacent figure.

**i** **N.B.:** with this working program pressure on the drive pedal only brings the squeegee to the work position (in contact with the floor), while the brush head remains in the rest position (raised from the floor). When the drive pedal is pressed both the suction motor and the traction motor are powered.

**i** **N.B.:** In the DS selector, the drying program symbol (C) is green (see “DS (DRIVE SELECT) SELECTOR”).

**i** **N.B.:** the grey symbols show working programs that are not active. the green symbols show working programs that are active.

**i** **N.B.:** when the drive pedal is released the suction motor will stop with the respective delay. After the “Reset Delay” time all the squeegee support is taken to the rest position (raised off the floor). by pressing the forward movement pedal it will start working with the same program and with the same parameters that were set before it stopped.

**i** **N.B.:** if you reverse with this program active, the squeegee support is put in the rest position (raised off the floor) and the suction motor is switched off with the relative delay.

The icons that may be visible on the control panel display are:

1. FFM symbol, if visible it shows that the system is operating.
2. FSS symbol, if visible it shows that the system is operating.
3. Working lights symbol, if visible it shows that the working lights are on.
4. General alarm symbol.

**⚠** **ATTENTION:** if visible stop the machine, to continue working (read the paragraph "ALARM SCREEN").

5. Eco-Mode button.

**i** **N.B.:** if you press the HILLYARD ECO MODE button (5) you start the working program currently in use in economic mode, to remove the economic mode read the section "HILLYARD ECO MODE".

6. Menu button.
7. Rear view camera button.

**i** **N.B.:** pressing the rear view camera button (7) if present the video camera on the back of the machine will start, read the section "REAR VIEW VIDEO CAMERA (OPTIONAL)" to continue working.

8. Text indicator.

**i** **N.B.:** the text indicator (8) shows which zone program has been selected, or whether the machine is in transport mode if the word "DRIVE" is visible.

**i** **N.B.:** If you need to activate the dipped headlights when working, read the section "WORKING LIGHTS".

**⚠** **ATTENTION:** The drying without scrubbing operation should only be carried out if the device was used beforehand to carry out a scrubbing without drying operation.

**⚠** **ATTENTION:** never switch off the machine with the squeegee in contact with the floor

### SCRUBBING WITH DRYING

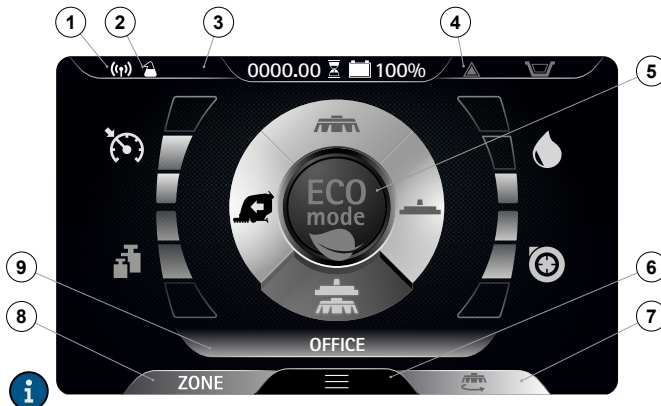

By selecting the "SCRUBBING WITH DRYING" program, the command display screen will appear as in the adjacent figure.

**i** **N.B.:** with this working program pressure on the drive pedal brings the brush heads and the squeegee to the work position (in contact with the floor). When the drive pedal is pressed, all the motors are powered. The brush head solenoid valve and the water system pump are powered up (only if the detergent solution is other than zero).

**i** **N.B.:** In the DS selector, the scrubbing with drying program symbol (D) is green (see "DS (DRIVE SELECT) SELECTOR").

**N.B.:** the grey symbols show working programs that are not active. the green symbols show working programs that are active.

**i** **N.B.:** when the drive pedal is released all the brush head motors and the suction motor stop with the respective delays. After the "Reset Delay" time all the brush heads and the squeegee body are taken to the rest position (raised off the floor). by pressing the forward movement pedal it will start working with the same program and with the same parameters that were set before it stopped.

**i** **N.B.:** if you reverse with this program active the brush head will remain in contact with the floor, the motor will continue working but the solenoid valve will not deliver the detergent solution to the brushes. The squeegee support is put in the rest position (raised off the floor) and the suction motor is switched off with the relative delay.

The icons that may be visible on the control panel display are:

1. FFM symbol, if visible it shows that the system is operating.
2. FSS symbol, if visible it shows that the system is operating.
3. Working lights symbol, if visible it shows that the working lights are on.
4. General alarm symbol.

**⚠ ATTENTION:** if visible stop the machine, to continue working (read the paragraph “ALARM SCREEN”).

5. Eco-Mode button.

**i N.B.:** if you press the HILLYARD ECO MODE button (5) you start the working program currently in use in economic mode, to remove the economic mode read the section “HILLYARD ECO MODE”.

6. Menu button.

7. Rear view camera button.

**i N.B.:** pressing the rear view camera button (7) if present the video camera on the back of the machine will start, read the section “REAR VIEW VIDEO CAMERA (OPTIONAL)” to continue working.

8. Zone button

**i N.B.:** if you need to change the program used when working, press the Zone button (8) (read the section “ZONE PROGRAM MODE”).

9. Text indicator.

**i N.B.:** in the text indicator (9) it is possible to see that the zone program has been selected or whether you are in transport mode if there is the word “DRIVE”.

**i N.B.:** If you need to activate the dipped headlights when working, read the section “WORKING LIGHTS”.

**⚠ ATTENTION:** never switch off the machine while the squeegee and/or brush head is in contact with the floor

## ECO MODE

In the centre of the DS selector there is the ECO-MODE key (1). Press it to activate the “ECO-MODE” program, which provides the best possible performance in terms of consumption and cleaning. To activate the ECO-MODE program, proceed as follows:

1. Sit on the driver's seat.

2. Insert the key (1) into the main switch on the control panel. Set the main switch to “I” (Fig.1).

3. Select the ECO-MODE working program with the button (2) at the centre of the DS selector (Fig.2).

**i N.B.:** the grey ECO-MODE key means that the eco mode is not active. The green ECO-MODE key means that the eco mode is active. In addition, when ECO-MODE is active, on the text indicator row (3) on the display, the words “ECO mode” will appear (Fig.2).

**i N.B.:** pressing the button (2) on the DS selector (Fig.2) will activate the SCRUBBING WITH DRYING program. If you wish to use another working program, select it using the DS selector (read the section “DS SELECTOR (DRIVE SELECT)”).

4. When you push the dead man's lever (4), the machine will begin to move (Fig.3).

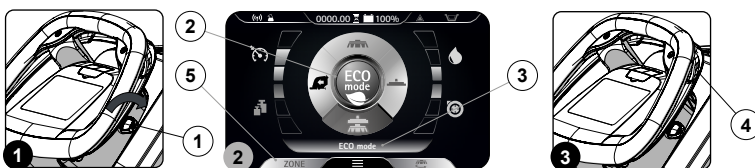

**i N.B.:** if the button (2) is pressed when working in ECO-MODE, the machine will shift to MANUAL MODE, leaving the program in use at the time active (Fig.4).

**i N.B.:** if the “ZONE” button (4) is pressed when working in ECO-MODE, the machine will shift to PROGRAM ZONE mode (Fig.2); as soon as button (4) is pressed, the screen enabling you to select the working zone will appear on the display (Fig.5).



## MANUAL MODE

To activate the MANUAL-MODE program, proceed as follows:

1. Sit on the driver's seat.
2. Insert the key (1) into the main switch on the control panel. Set the main switch to "I" (Fig.1).
3. Using the DS selector (2), select the working program you want; see "DS SELECTOR (DRIVE SELECT)" (Fig.2).

**i N.B.:** by selecting one of the three working programs on the DS selector, ECO-MODE will be automatically activated.

4. Deactivate ECO-MODE by pressing the button (3) at the centre of the DS selector (Fig.2); the display will move from ECO-MODE (Fig.2) to MANUAL MODE (Fig.3).

**i N.B.:** the grey ECO-MODE key means that the eco mode is not active. The green ECO-MODE key means that the eco mode is active. In addition, when ECO-MODE is not active, on the text indicator row (4) on the display, the word "MANUAL" will appear (Fig.2).

5. When you push the dead man's lever (5), the machine will begin to move (Fig.4).

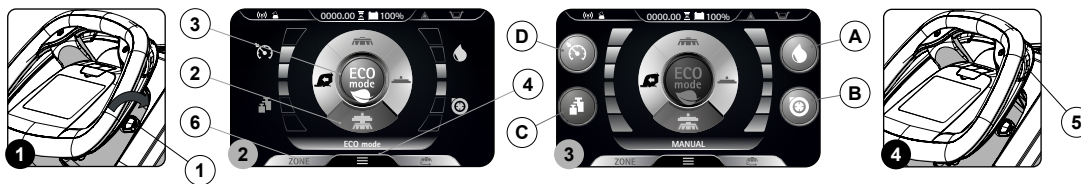

**i N.B.:** if the button (3) (Fig.2) is pressed when working in MANUAL MODE, the machine will shift to ECO-MODE, leaving the program in use at the time active.

**i N.B.:** if the "ZONE" button (6) is pressed when working in MANUAL MODE, the machine will shift to PROGRAM ZONE mode; as soon as button (6) is pressed, the screen enabling you to select the working zone will appear on the display (Fig.5).



In manual mode the visible buttons are:

- A. Water flow selector
- B. Suction motor performance level.
- C. Pressure level exercised on the central brush head.
- D. Maximum forward movement speed level.

**i N.B.:** the four keys are always present but can be selected depending on the working mode selected. Particularly:

- Transfer: the visible button will be that of the maximum speed.
- Scrubbing without drying: the buttons visible will be those of the maximum speed, the water flow selector and the pressure exercised on the central brush head.
- Drying: the buttons visible will be those of the maximum speed and the suction motor performance level.
- Scrubbing with drying: the buttons visible will be those of the maximum speed, the water flow selector, the pressure exercised on the central brush head and performance level of the suction motor.

**i N.B.:** the disabled buttons and the respective indicators are grey.

**i N.B.:** each time one of the enabled keys is pressed, it increases the relative level in a cyclical manner. Only the detergent solution adjustment permits zero level.



## PROGRAM ZONE MODE

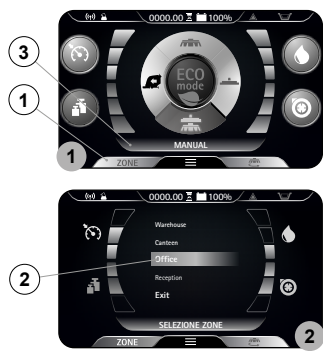

The zone programs are programs saved in the machine's memory, the parameter levels:

- Pressure exercised on the central brush head
- Forward speed
- Adjustment of the detergent solution flow
- Suction motor efficiency

they are fixed and have been created based on the type of environment in which you want to work. To select one of the zone programs, do as follows:

1. From any screen, press the "ZONE" button (1) (**Fig.1**).
2. As soon as the button (1) is pressed, the "ZONE SELECTION" menu will be displayed (**Fig.2**). Select one of the programs.

**i** **N.B.:** the name of the zone program selected is displayed in the text indicator (3) (**Fig.1**).

**i** **N.B.:** to exit the zone program:

- From the zone program menu select the "EXIT" key
- Enable and then disable the ECO-MODE key.

**i** **N.B.:** the light blue ZONE key shows that the selected zone is active, in this case the ECO-MODE button is not active.

## SMART DRYING MODE



When moving from the scrubbing with drying program to the transfer program (read the paragraph "DS (DRIVE SELECT) SELECTOR"), the drying function is delayed by a "Reset Delay" time.

**i** **N.B.:** While the function is active, the image in **Fig.1** will be displayed on the control panel.

At the end of the "Reset Delay" time, the squeegee body is moved into the rest position (raised off the floor) and the suction motor is switched off with its "Reset Delay" time.

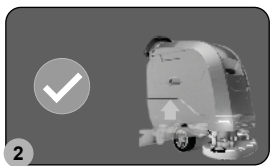

**i** **N.B.:** it is possible to cancel this function in advance by pressing the "X" symbol as seen in **Fig.1**.

**i** **N.B.:** at the end of the smart drying function, the image in **Fig.2** will be displayed on the control panel.

## REVERSE GEAR

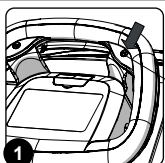

This machine is equipped with electronic traction control. To reverse, proceed as follows:

1. Press the "REVERSE ACTIVATION - DEACTIVATION" button (1) on the control handlebars (**Fig.1**).
2. Press the dead man's lever (2) (**Fig.2**) to start the machine moving in reverse.

**⚠ CAUTION:** the reverse speed is lower than the forward speed to comply with current health and safety standards.

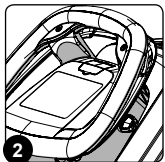

**i** **N.B.:** to disable reverse movement, press the button (1) on the control handlebars again (**Fig.1**).

**i** **N.B.:** as soon as the button (1) is pressed, the buzzer will sound to indicate that reverse mode has been activated.

**i** **N.B.:** if reverse gear is engaged with the squeegee in its working position, the machine will begin moving backwards as soon as the dead man's lever is pressed, and the squeegee body will rise to its idle position.

**i** **N.B.:** if reverse gear is engaged with the brush head in its working position, the machine will begin moving backwards as soon as the dead man's lever is pressed, and the brush head body will remain in its working position, but the solenoid valve will stop dispensing detergent solution.

**EXTRA BRUSH HEAD PRESSURE**

This machine is capable of increasing the pressure exerted upon the brushes during the work cycle. This can be done in the following manner:

1. Check that the brush head body is in contact with the floor, if not select in the DS selector the programs “SCRUBBING WITH DRYING” OR “SCRUBBING WITHOUT DRYING” (Fig.1).
2. Press the “EXTRA PRESSURE ACTIVATION - DEACTIVATION” button (1) on the control handlebars (Fig.2).
3. Press the dead man’s lever (2) (Fig.3) to start the working cycle.

**i** **N.B.:** as soon as the button (1) is pressed, the control display will show the “POWER” screen (Fig.4). In the middle of the screen there is a graphic symbol (3) and a numeric symbol (4) that represent a countdown.

**i** **N.B.:** when the extra-pressure function is activated the countdown starts, during this period of time a pressure stronger than the standard pressure is exerted on the brush head body.

**i** **N.B.:** at the end of the countdown you return to the working screen that was previously used and the pressure on the brush head goes back to standard.

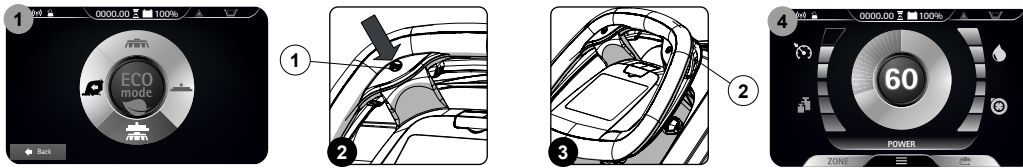

**FIMAP SOLUTION SAVER SYSTEM (FSS)**

Upon request, the machine can be fitted with the FIMAP SOLUTION SAVER (FSS) system, which allows you to dose in a separated way the detergent with the water in the solution tank. To start it do as follows.

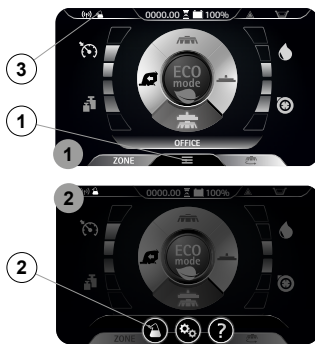

1. With the machine on, press the menu button (1) on the working screen (Fig.1).
2. Press the FSS system activation/deactivation button (2) (Fig.2).

**i** **N.B.:** if the symbol (2) is grey the FSS system is not active, if the symbol (2) is green the FSS system is active.

**i** **N.B.:** to exit the menu screen wait a short time without pressing anything, or else press on any point of the display (except one of the displayed buttons).

**i** **N.B.:** the FSS system activates when the electric pump in the machine's water system starts.

**i** **N.B.:** if the FSS system is activated, the relative symbol (3) is displayed in the working screen.

**i** **N.B.:** if you want to deactivate the FSS system press button (2) again.

**⚠ ATTENTION:** before starting any work, remember to start the FSS system.

**i** **N.B.:** to return to the working screen press on any point of the screen, except the edges of the display or else wait three seconds without touching anything.

**FIMAP LONG RANGE (FLR) SYSTEM**

On request, the machine can be equipped with the FIMAP LONG RANGE (FLR) system, which enables productivity to be increased when working, by reducing the number of stops required to empty and fill the tanks, so that more square meters can be washed with the same amount of detergent solution. To start it do as follows.

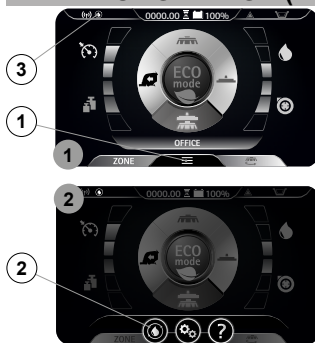

1. With the machine on, press the menu button (1) on the working screen (Fig.1).
2. Press the FLR system activation/deactivation button (2) (Fig.2).

**i** **N.B.:** if the symbol (2) is grey the FLR system is not active, if the symbol (2) is green the FLR system is active.

**i** **N.B.:** to exit the menu screen wait a short time without pressing anything, or else press on any point of the display (except one of the displayed buttons).

**i** **N.B.:** the FLR system activates when the electric pump in the machine's water system starts.

**i** **N.B.:** if the FLR system is activated, the relative symbol (3) is displayed in the working screen.

**i** **N.B.:** if you want to deactivate the FLR system press button (2) again.

**ATTENTION:** before starting any work, remember to start the FLR system.

**N.B.:** to return to the working screen press on any point of the screen, except the edges of the display or else wait three seconds without touching anything.

### AUTOMATIC REQUEST FOR TECHNICAL ASSISTANCE (FFM VERSIONS)

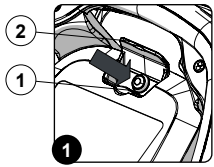

The machine has an automatic service for activating an urgent technical assistance request. To activate this function, the operator has to press the button (2) under the hatch (1) bearing the symbol "SOS" (Fig. 1).

**N.B.:** in order to activate this urgent technical assistance request the machine needs to be equipped with the FIMAP FLEET MANAGEMENT kit.

**N.B.:** in order to send a technical assistance request the machine needs to be on and should be in a zone with data traffic coverage.

### TUTORIAL

The machine's internal memory contains tutorials that explain:

- The initial commissioning of the machine (document in IT-EN-ES-FR-DE).
- The routine maintenance to be carried out (document in IT-EN-ES-FR-DE).
- The machine's use and maintenance manual (document in IT-EN-ES-FR-DE).

To start them do as follows.

1. With the machine on, press the menu button (1) on the working screen (Fig.1).
2. Press the TUTORIAL button (2) (Fig.2).

**N.B.:** to return to the working screen press on any point of the screen, except the edges of the display or else wait three seconds without touching anything.

3. On the tutorial screen (Fig.3) select the topics you want to study:

- Using the machine.
- Daily maintenance.
- Extraordinary maintenance.

**N.B.:** select the "USING THE MACHINE" key (A) to view the video explaining the stages for preparing the machine for work (Fig.3).

**N.B.:** select the "DAILY MAINTENANCE" KEY (B) to view the video explaining the maintenance to be carried out every day (Fig.3). When this button is selected the screen regarding the selection of the videos to view will be displayed (Fig.4), you can view the following video tutorials:

- Draining and cleaning the recovery tank.
- Cleaning the vacuum tube and the squeegee body.
- Cleaning the suction motor filter.
- Draining and cleaning the solution tank and the water system filter.

**N.B.:** select the "EXTRAORDINARY MAINTENANCE" key (C) to see the video explaining the maintenance to be carried out daily (Fig.3). When this button is selected the screen regarding the selection of the videos to view will be displayed (Fig.4), you can view the following video tutorials:

- Replacing the squeegee rubber blades.
- Replacing the brush head brushes.
- Adjusting the squeegee rubber blades.

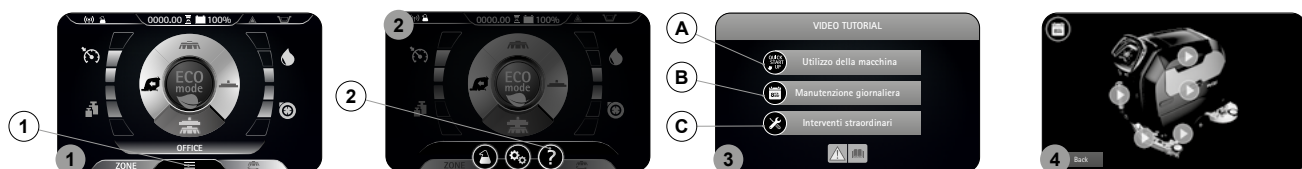

**VACUUM WAND KIT**

On request, the machine can be equipped with the liquid vacuum wand kit; in order to use this, proceed as follows:

1. Using the DS selector on the control display (Fig.1), select the “transfer” program” (1).
2. Turn off, turn the key (2) a quarter turn anticlockwise (Fig.2).
3. Open the storage compartment by turning the handle (3) (Fig.3).
4. Remove all the vacuum kit components from the storage compartment.
5. Assemble the steel extension tube (Fig.4).
6. Insert the vacuum brush (5) into the extension tube (4) (Fig.5).

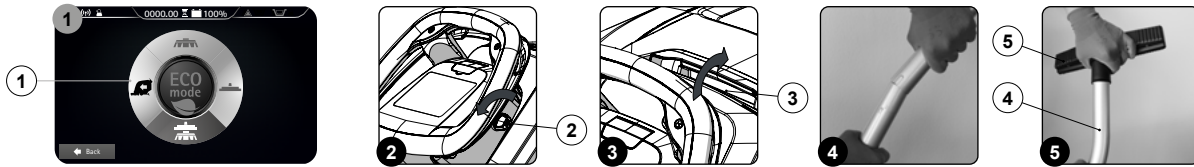

7. Connect the wand kit vacuum tube (6) to the extension tube (4) (Fig.6).
8. Remove the squeegee vacuum tube (7) from the sleeve (8) in the squeegee body (Fig.7).
9. Connect the wand kit vacuum tube (6) to the squeegee vacuum tube (7) (Fig.8).
10. Turn on the machine and turn the key (2) a quarter turn clockwise (Fig.9).
11. Activate the vacuum control kit by pressing the button (9) (Fig.10).

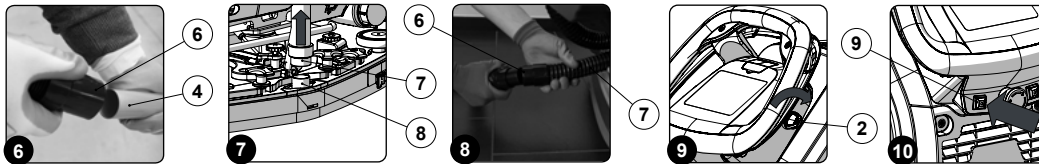

**i** N.B.: As soon as the button (9) is pressed, the LED on it will light up (Fig.10).

**i** N.B.: As soon as the button (9) on the control display is pressed, the symbol for the vacuum wand kit will appear (Fig.11).

**i** N.B.: With the vacuum wand kit active, the traction and work functions are deactivated.

**!** **WARNING:** never pick up solid matter such as dust, cigarette stubs, paper, etc.

**!** **CAUTION:** Never collect gases, explosive/inflammable liquids or powders, nor acids and solvents! These include gasoline, paint thinners and fuel oil (which, when mixed with the vacuum air, can form explosive vapours or mixtures), and also non-diluted acids and solvents, acetones, aluminium and magnesium powders. These substances may also corrode the materials used to construct the machine.

**!** **CAUTION:** If the machine is used in dangerous areas (e.g. petrol stations), the relative safety standards must be observed. It is forbidden to use the machine in environments with a potentially explosive atmosphere.

12. After completing the task, the wand kit can be fixed in the side support on the machine (Fig.12).

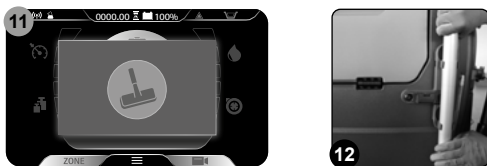

**SPRAY GUN KIT**

On request, the machine can be equipped with the spray gun kit. To use this, proceed as follows:

1. Using the DS selector on the control display (Fig.1), select the “transfer” program” (1).
2. Release the spray gun accessory (2) (at the back of the machine) from the retainers (Fig.2).
3. Activate the optional spray gun kit by pressing the button (3) on the back of the machine (Fig.3).

**i** N.B.: As soon as the button (3) is pressed, the LED on it will light up (Fig.3).

**i** N.B.: As soon as the button (3) on the control display is pressed, the symbol for the spray gun kit will appear (Fig.4).

**i** N.B.: With the spray gun kit active, the traction and work functions are deactivated.

**!** **CAUTION:** when using the optional tank cleaning kit, you are advised to always wear goggles to avoid any risk of serious injury to your eyes.

**i** N.B.: Before using the optional tank cleaning kit, check the level indicator (4) to see how much solution there is in the solution tank (Fig.5).

4. Activate the solution jet by pressing the lever in the tank cleaning accessory. Make sure the jet is pointing into the tank before pressing the lever.

**i** N.B.: To adjust the solution jet from the tank cleaning accessory, turn the knob (5) on the accessory itself (Fig.6).

**i** N.B.: To adjust the intensity of the solution jet from the tank cleaning accessory, turn the knob (6) on the accessory itself (Fig.7).

**i** N.B.: To stop the solution jet, use the lever (7) on the tank cleaning accessory (Fig.8).

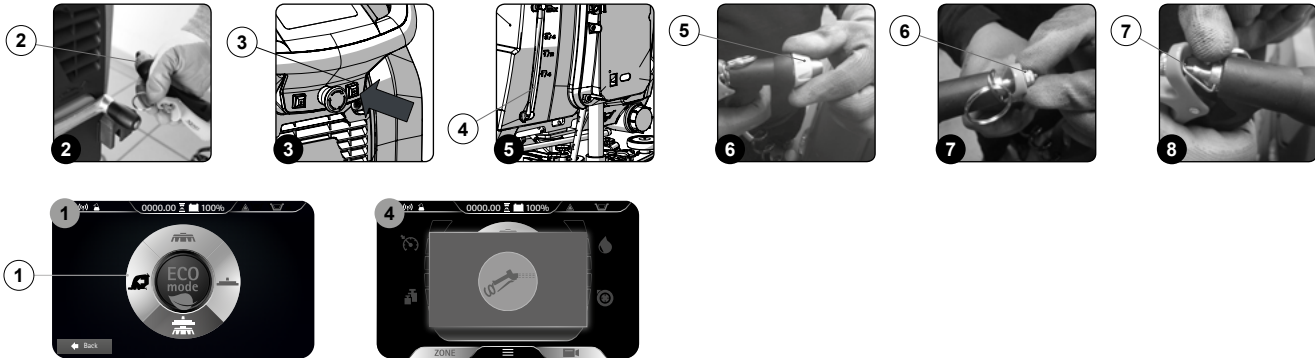

### ALARM SCREEN



When an error occurs the symbol (1) is displayed in the information field (Fig. 1), it remains visible until the error is resolved. The "ERROR" window will also be displayed in superimposition (Fig.2), in it are described the number of the alarm, the group it belongs to and a brief description. When an error occurs, do as follows:

1. Stop the machine and press the button (2) (Fig.2).
2. If the error persists, switch off the machine, wait for at least ten seconds and switch on the machine.



**i** N.B.: to close the error screen press the button (3) (Fig.2).

3. If the error persists contact the nearest service centre.

**i** N.B.: the symbol (1) (Fig.1) remains visible until the error is resolved.

### BATTERY DISCONNECT SWITCH

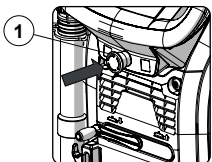

If any serious problems are encountered during the work operations, press the battery disconnect button (1) on the electrical system carter.

**⚠ CAUTION:** this command interrupts the electrical circuit that goes from the batteries to the machine system.

**i** N.B.: To recommence work having stopped and once the problem has been resolved, switch off the machine and turn the knob (1) in the direction of the arrows indicated on it.

### OVERFLOW DEVICE

The machine is NOT equipped with an overflow device, because the volume of the recovery tank is greater than the capacity of the solution tank. In extraordinary cases, there is a mechanical device (float) under the recovery tank lid that, when the recovery tank is full, shuts off the air to the vacuum motor intake to protect it; the sound of the suction motor will then be deeper. Empty the recovery tank (see "[EMPTYING THE RECOVERY TANK](#)").

## AT THE END OF THE WORK

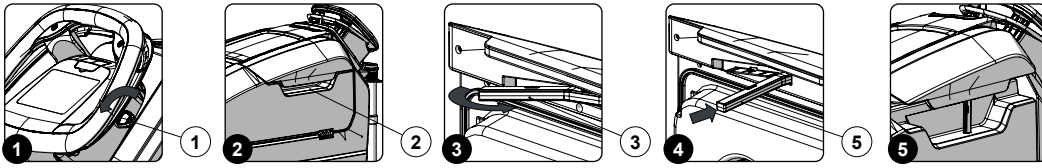

At the end of the work, and before carrying out any type of maintenance, perform the following operations:

1. Take the appliance to the dedicated dirty water drainage area.
2. Switch off the machine by turning the main switch (1) to "0", making a quarter turn of the key in the direction of the arrow (Fig.1). Remove the key from the instrument panel.
3. Carry out all the procedures listed in the chapter "[RECOMMENDED PERIODIC MAINTENANCE](#)" indicated in the column "AT THE END OF THE WORK".
4. Take the machine to the designated machine storage place.

**⚠ ATTENTION:** Park the machine in an enclosed place, on a flat surface; near the machine there must be no objects that could either damage it, or be damaged through contact with it.

5. Secure the machine, see the section titled "[SECURING THE MACHINE](#)".

**⚠ ATTENTION:** if the machine is left unused for more than one whole day, remove the brush from the brush head body, and the squeegee body from the squeegee support.

6. Grip the handle (2) on the right-hand side of the recovery tank cover (Fig.2) and turn the tank cover as far as it will go.
7. Grip the prop (3) and turn it as far as it will go (Fig.3).
8. Block the rotation of the prop (3) by pushing it towards the inside of the cover (Fig.4).
9. Grip the handle (2) and turn the recovery tank cover until the prop (3) is resting on the recovery tank (Fig.5).

## RECOMMENDED MAINTENANCE OPERATIONS

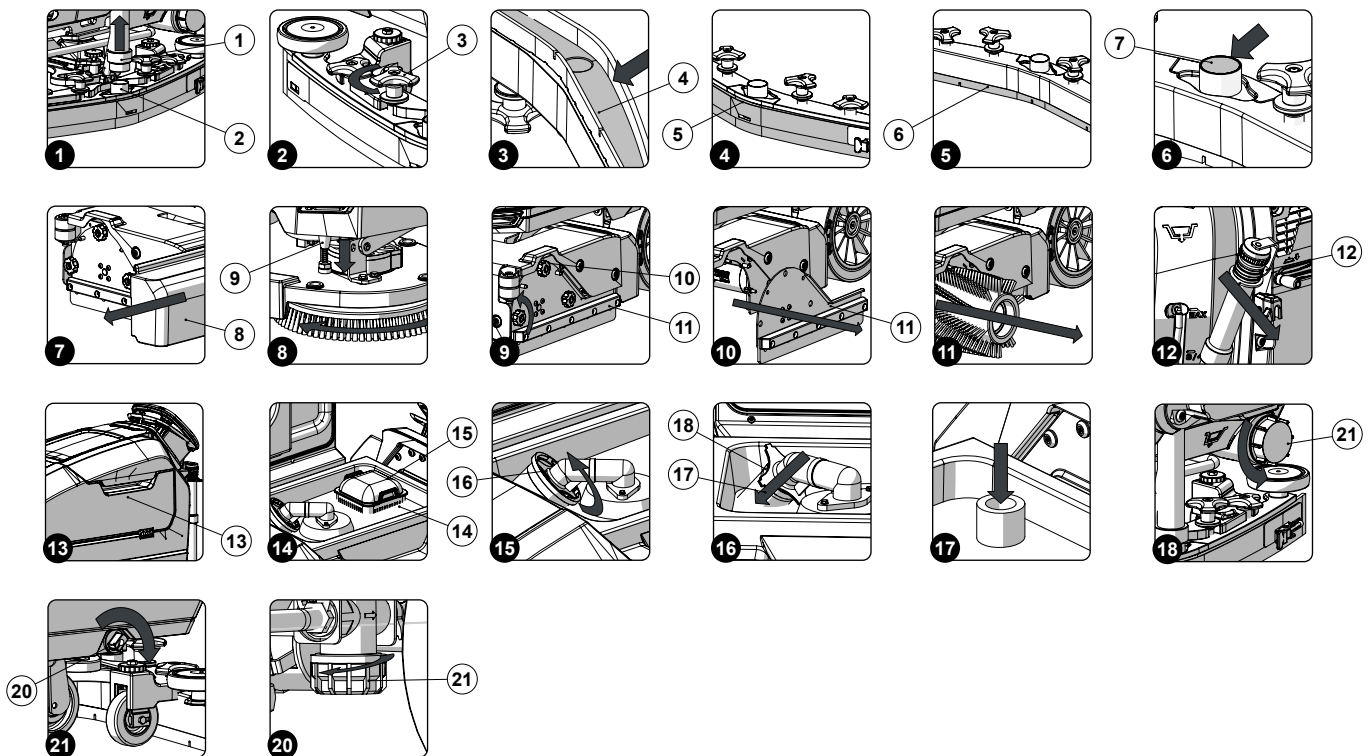

INTERVAL	MACHINE COMPONENTS	PROCEDURE
DAILY; BEFORE A LONG PERIOD OF INACTIVITY	Squeegee	Clean the vacuum chamber; the squeegee rubber blades; the vacuum nozzle (see <a href="#">“CLEANING THE SQUEEGEE BODY”</a> ).
	Debris hopper	Empty the debris hopper and clean inside (see <a href="#">“CLEANING THE DEBRIS HOPPER (SWEEPING VERSION)”</a> ).
	Brush head brushes	Clean the brushes on the brush head body (see <a href="#">“CLEANING THE BRUSH HEAD BODY BRUSHES (SCRUBBING VERSION)”</a> ).
		Clean the brushes on the brush head body (see <a href="#">“CLEANING THE BRUSH HEAD BODY BRUSHES (SWEEPING VERSION)”</a> ).
	Recovery tank	At the end of every working day, empty the recovery tank (see <a href="#">“EMPTYING THE RECOVERY TANK”</a> ).
		At the end of every working day, after having emptied the recovery tank, clean the vacuum system filters (see <a href="#">“CLEANING THE RECOVERY TANK FILTERS”</a> ).
At the end of every working day, after having emptied the recovery tank, clean the vacuum tube (see <a href="#">“CLEANING THE VACUUM TUBE”</a> ).		
Solution tank	At the end of every working day, empty the solution tank (see <a href="#">“EMPTYING THE SOLUTION TANK”</a> ).	
WEEKLY	Machine water system	Clean the filter in the machine's water system (see <a href="#">“CLEANING THE WATER SYSTEM FILTER”</a> ).
	Squeegee rubber blades	Check that the rubber blades on the squeegee body are intact and inspect for wear; if necessary, replace these (see <a href="#">“REPLACING THE SQUEEGEE BODY RUBBER BLADES”</a> ).
	Brush head brushes	Check that the brushes on the brush head body are intact and inspect for wear; if necessary, replace these (see <a href="#">“REPLACING THE BRUSH HEAD BODY BRUSHES (SCRUBBING VERSION)”</a> ).
Check that the brushes on the brush head body are intact and inspect for wear; if necessary, replace these (see <a href="#">“REPLACING THE BRUSH HEAD BODY BRUSHES (SWEEPING VERSION)”</a> ).		
MONTHLY	Squeegee rubber blade levelling	Check that the rubber blades on the squeegee body are level and if necessary, adjust these (see <a href="#">“ADJUSTING THE SQUEEGEE BODY RUBBER BLADES”</a> ).

Before performing any routine or extraordinary maintenance operation, proceed as follows:

1. Take the machine to the maintenance area.



**N.B.:** the place given over to this operation must comply with current environmental protection regulations.

2. Make sure the machine is in a safe condition (see chapter [“MACHINE SAFETY MEASURES”](#)).



**CAUTION:** it is recommended to wear the appropriate PPE (Personal Protective Equipment), suitable for the work to be carried out.

## CLEANING THE SQUEEGEE BODY

The careful cleaning of the whole vacuum unit ensures better drying and cleaning of the floor as well as a longer suction motor life. To carry out the cleaning of the squeegee body, proceed as follows:

1. Remove the vacuum hose (1) from the vacuum nozzle (2) on the squeegee unit (**Fig.1**).
2. Completely unscrew the knobs (3) on the squeegee body pre-assembly (**Fig.2**).
3. Remove the squeegee body from the slits in the squeegee connector.
4. Thoroughly clean the squeegee body vacuum chamber (4) with a jet of water, and then with a damp cloth (**Fig.3**).



**N.B.:** The place given over to this operation must comply with current environmental protection regulations.

5. Thoroughly clean the squeegee body rear rubber blade (5) with a jet of water, and then with a damp cloth (**Fig.4**).
6. Thoroughly clean the squeegee body front rubber blade (6) with a jet of water, and then with a damp cloth (**Fig.5**).
7. Use a jet of water and then a damp cloth to thoroughly clean the vacuum nozzle (7) (**Fig.6**).
8. Proceed in the opposite order to reassemble all the parts.



**N.B.:** Check the wear of the rear rubber blade (5) on the squeegee body; if the edge of the rubber in contact with the floor is worn, replace it. Refer to [“REPLACING THE SQUEEGEE BODY RUBBER BLADES”](#).



**N.B.:** Check the wear of the front rubber blade (6) on the squeegee body; if the edge of the rubber in contact with the floor is worn, replace it. Refer to [“REPLACING THE SQUEEGEE BODY RUBBER BLADES”](#).

## CLEANING THE DEBRIS HOPPER (SWEEPING VERSION)

To clean the debris hopper, proceed as follows:

1. Use the moulded handle to extract the debris hopper (8) (**Fig.7**) and empty it.



**N.B.:** The place given over to this operation must comply with current environmental protection regulations.

2. Clean the inside with a jet of water, and use a brush to remove any residual impurities if necessary.
3. Proceed in the opposite order to reassemble all the parts.

## CLEANING THE BRUSH HEAD BRUSHES (SCRUBBING VERSION)

Careful cleaning of the brush guarantees better cleaning of the floor, as well as a longer brush head gearmotor lifespan. To clean the brush, proceed as follows:

1. Go to the front of the machine.
2. Press the brush-holder plate retainer (9) and simultaneously rotate the brush in the direction shown in the image (**Fig.8**).



**ATTENTION:** **Fig.8** shows the rotation direction of the left-hand brush.

3. When brush rotation is prevented, turn until the button on the brush is disengaged from the coupling spring on the brush-holder plate.
4. Repeat the same operation for the right-hand brush.
5. Clean the brush under running water to remove any impurities from its bristles.
6. See "[INSTALLING THE BRUSH \(SCRUBBING VERSION\)](#)" for instructions on refitting the brushes in the brush head body.



**N.B.:** Check that the bristles are not worn; in the event of excessive wear, replace the brush (the bristles should be at least 10 mm long). See "[REPLACING THE BRUSH \(SCRUBBING VERSION\)](#)" to replace the brush.

## CLEANING THE BRUSH HEAD BRUSHES (SWEEPING VERSION)

Careful cleaning of the brush guarantees better cleaning of the floor, as well as a longer brush head gearmotor lifespan. To clean the brush, proceed as follows:

1. Go to the front of the machine.
2. Remove the knobs (10) that fix the left-hand side carter (11) in place by turning anti-clockwise (**Fig.9**).
3. Remove the left lateral carter (11) (**Fig.10**).
4. Extract the brush from the tunnel (**Fig.11**).
5. Repeat the same operation for the right-hand brush.
6. Clean the brush under running water to remove any impurities from its bristles.
7. See "[INSTALLING THE BRUSH \(SWEEPING VERSION\)](#)" for instructions on refitting the brushes in the brush head body.



**N.B.:** Check that the bristles are not worn; in the event of excessive wear, replace the brush (the bristles should be at least 10 mm long). See "[REPLACING THE BRUSH \(SWEEPING VERSION\)](#)" to replace the brush.

## DRAINING THE RECOVERY TANK

Proceed as follows to empty the recovery tank:

1. Release the recovery tank drainage tube (12) (at the back of the machine) from the retainers (**Fig.12**).
2. Bend the end of the drainage tube, so as to create a choke and prevent the contents from coming out, put the tube on the discharge surface, unscrew the cap and gradually release the tube.



**N.B.:** The place given over to this operation must comply with current environmental protection regulations.

3. Repeat the operations in reverse order to reassemble all the parts.

## CLEANING THE RECOVERY TANK FILTERS

To clean the recovery tank (without the optional tank cleaning kit), proceed as follows:

1. Grip the handle (13) on the left-hand side of the recovery tank (**Fig.13**) and turn the tank cover as far as it will go, until it reaches the maintenance position.
2. Remove the dirty water basket/filter (14) from the support (**Fig.14**).
3. Remove the basket cover and clean the basket/filter and the basket cover (15) under a jet of running water.



**N.B.:** Use a spatula or brush to eliminate any dirt that is particularly difficult to remove.

4. Use a cloth to dry the basket/filter and basket cover, and place them back inside the recovery tank.
5. Remove the filter protection cup (16), turning it in the direction of the arrow (**Fig.15**).
6. Remove the suction motor filter (17), taking care not to lose the support tie (18) inside the recovery tank (**Fig.16**).
7. Rinse both the cup and the filter carefully under running water.



**i** **N.B.:** Use a spatula or brush to eliminate any dirt that is particularly difficult to remove.

8. Rinse the inside of the recovery tank with a jet of water. If necessary, use a spatula to remove any sludge that may have accumulated at the bottom of the tank.
9. Repeat the operations in reverse order to reassemble all the parts.

### CLEANING THE VACUUM TUBE

Careful cleaning of the vacuum hose guarantees better cleaning of the floor as well as a longer suction motor life. Proceed as follows to clean the vacuum hose:

1. Grip the handle (13) on the left-hand side of the recovery tank (**Fig.13**) and turn the tank cover as far as it will go, until it reaches the maintenance position.
2. Remove the dirty water basket/filter (14) from the support (**Fig.14**).
3. Rinse the inside of the vacuum tube with a jet of running water (**Fig.17**).
4. Repeat the operations in reverse order to reassemble all the parts.

### EMPTYING THE SOLUTION TANK

Proceed as follows to empty the solution tank:

1. Unscrew the cap (21) for the solution tank dumping system (**Fig.18**); the cap is located at the rear of the machine.
2. With the solution tank empty, rinse the inside of the solution tank with a jet of running water.

### CLEANING THE WATER SYSTEM FILTER

In order to clean the water system's filter, do the following:

1. Block the tap outflow, rotating the knob (20) in the direction of the arrow (**Fig.21**).
2. Go to the right-hand side of the machine and loosen the detergent solution filter cap (21) (**Fig.20**).
3. Remove the filter cartridge and rinse under a jet of water, using a brush to eliminate any impurities if necessary.
4. Once the filter cartridge is clean, repeat the operations in the opposite order to reassemble all the parts.

## EXTRAORDINARY MAINTENANCE WORK

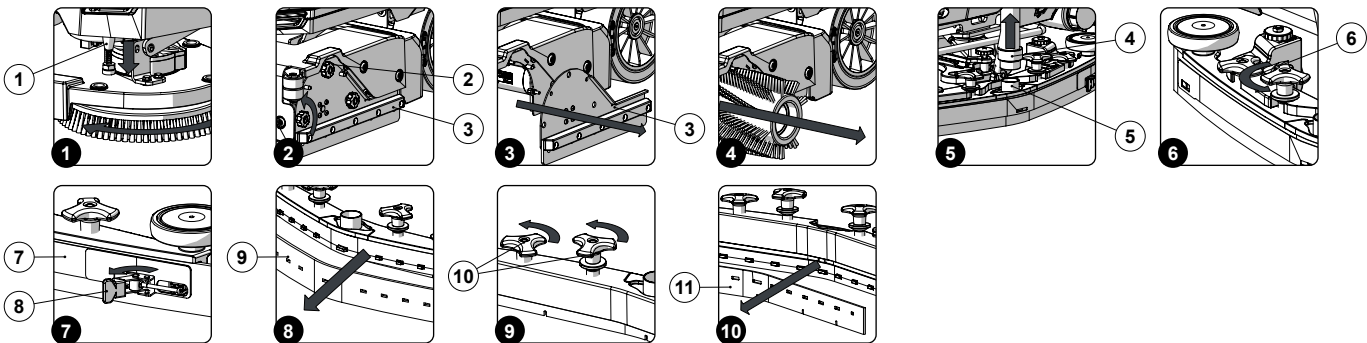

### REPLACING THE BRUSH (SCRUBBING VERSION)

The good condition of the brush guarantees better cleaning of the floor, as well as a longer brush head gearmotor lifespan. To replace the brush, proceed as follows:

1. Go to the front of the machine.
2. Press the brush-holder plate retainer (1) and simultaneously rotate the brush in the direction shown in the image (**Fig.1**).

**⚠ ATTENTION:** **Fig.1** shows the rotation direction of the left-hand brush.

3. When brush rotation is prevented, turn until the button on the brush is disengaged from the coupling spring on the brush-holder plate.
4. Repeat the same operation for the right-hand brush.
5. See "[INSTALLING THE BRUSH \(SCRUBBING VERSION\)](#)" for instructions on fitting the new brushes in the brush head body.

### REPLACING THE BRUSH (SWEEPING VERSION)

The good condition of the brush guarantees better cleaning of the floor, as well as a longer brush head gearmotor lifespan. To replace the brush, proceed as follows:

1. Go to the front of the machine.
2. With the brush head raised from the floor, turn the knobs (2) that hold the left lateral carter (3) in place anti-clockwise (**Fig.2**).
3. Remove the left lateral carter (3) (**Fig.3**).
4. Extract the brush from the tunnel (**Fig.4**).
5. Repeat the same operation for the right-hand brush.
6. See "[INSTALLING THE BRUSH \(SWEEPING VERSION\)](#)" for instructions on fitting the new brushes in the brush head body.

## REPLACING THE SQUEEGEE BODY RUBBER BLADES

Ensuring the integrity of the squeegee body's rubber blades guarantees better floor cleaning and drying results, as well as a longer service life for the suction motor. In order to replace the squeegee body's rubber blades, do the following:

1. Remove the vacuum hose (4) from the vacuum nozzle (5) on the squeegee body (**Fig.5**).
2. Completely unscrew the knobs (6) on the squeegee body pre-assembly (**Fig.6**).
3. Remove the squeegee body from the slits in the squeegee connector.

**To remove the rear squeegee rubber blade, proceed as follows:**

- Remove the rear rubber blade compression plate (7), and release the stop (8) at the rear of the squeegee (**Fig.7**).
- Remove the rear rubber blade (9) from the squeegee body (**Fig.8**).
- Replace the worn rubber blade with a new one.

**i** **N.B.:** The rubber blade can be rotated symmetrically to be used more than once.

- Repeat the operations in reverse order to reassemble all the parts.

**To remove the front squeegee rubber blade, proceed as follows:**

- Completely unscrew the knobs (10) on the squeegee body pre-assembly (**Fig.9**); this will cause the internal squeegee body to move downwards, and the front rubber blade can then be removed.
- Remove the front rubber blade (11) from the squeegee's internal body (**Fig.10**).
- Replace the worn rubber blade with a new one.

**i** **N.B.:** The rubber blade can be rotated symmetrically to be used more than once.

- Repeat the operations in reverse order to reassemble all the parts.

**i** **N.B.:** Before using the machine, remember to adjust the squeegee body: see the section titled "[ADJUSTING THE SQUEEGEE BODY'S RUBBER BLADES](#)".

**i** **N.B.:** It is recommended to replace both squeegee body blades in order to ensure good results when drying the floor.

## ADJUSTMENT INTERVENTIONS

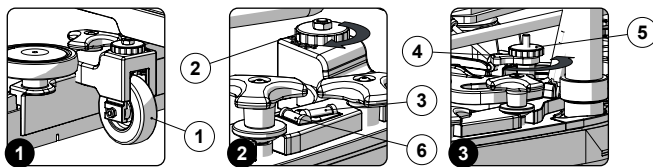

### ADJUSTING THE SQUEEGEE BODY'S RUBBER BLADES

The careful adjustment of the squeegee body rubber blades guarantees better cleaning of the floor.

**To adjust the height of the squeegee body:**

1. The distance of the squeegee rubber blades from the floor can be adjusted by changing the distance between the wheels (1) located on the squeegee support and the floor itself (**Fig.1**).
2. To adjust this distance, simply use the adjustment knobs (2) located on the squeegee support (**Fig.2**).

**i** **N.B.:** To decrease the distance, simply turn the adjustment levers (2) in the direction indicated by the arrows with the sign "-", while to increase the distance just follow the arrows with the "+" sign.

**i** **N.B.:** On decreasing the distance, the rubber blades on the squeegee body will move closer to the floor.

**i** **N.B.:** For effective drying, the wheels must be at the same distance from the floor.

**i** **N.B.:** Check for proper adjustment by looking at the instrument (3) positioned on the squeegee body (**Fig.2**).

**Adjusting the tilt of the squeegee body:**

3. The angle of incline of the squeegee body is adjusted by rotating the lever (4) located on the squeegee support (**Fig.3**).
4. To adjust the inclination of the squeegee body, loosen the knob (5) and tighten or loosen the lever (4) (**Fig.3**), until the squeegee body rubber blades are bent towards the outside evenly along the entire length by about 30° with respect to the floor.

**i** **N.B.:** Check for proper adjustment by looking at the instrument (6) positioned on the squeegee body (**Fig.2**).

**i** **N.B.:** Moving the lever (4) clockwise will raise the central part of the squeegee body from the floor.

5. Once the adjustment has been completed, tighten the knob (5).

## CHOOSING AND USING BRUSHES

### POLYPROPYLENE BRUSH (PPL)

Used on all types of floors. Good resistance to wear and tear, and hot water (no greater than 50°C.). PPL is non-hygroscopic and therefore retains its characteristics even when working in wet conditions.

### ABRASIVE BRUSH

The bristles of this type of brush are charged with highly aggressive abrasives. It is used to clean very dirty floors. To avoid floor damage, work only with the pressure strictly necessary.

### BRISTLE THICKNESS

Thicker bristles are more rigid and are therefore used on smooth floors or floors with small joints.

On uneven floors or those with deep joints, it is advisable to use softer bristles which can enter the gaps more easily.

Remember that when the bristles are worn and therefore too short, they will become rigid and are no longer able to penetrate and clean deep down. In this case, like with over-large bristles, the brush tends to jump.

### PAD HOLDER

The pad holder is recommended for cleaning shiny surfaces.

There are two types of pad holder:

1. The traditional pad holder is fitted with a series of anchor points that allow the abrasive floor pad to be held and dragged while working.
2. the CENTRE LOCK type pad holder not only has anchor points, but also a snap-type central locking system in plastic that allows the abrasive floor pad to be perfectly centred and held without any risk of it becoming detached. This type of pad holder is recommended above all for machines with more than one brush, where the centring of the abrasive discs is difficult.

MACHINE	CODE	QTY	BRISTLE	NOTES
MxL 65 Bt	422189	2	PPL 0.3	BLUE BRUSH
	422971	2	PPL 0.6	WHITE BRUSH
	422972	2	PPL 0.9	BLACK BRUSH
	422981	2	ABRASIVE	GREY BRUSH
	422973	2	-	PAD HOLDER
MxL 75 Bt	414272	2	PPL 0.3	BLUE BRUSH
	414270	2	PPL 0.6	WHITE BRUSH
	414273	2	PPL 0.9	BLACK BRUSH
	414271	2	ABRASIVE	GREY BRUSH
	405508	2	-	PAD HOLDER
MxL 85 Bt	445562	2	PPL 0.3	BLUE BRUSH
	445563	2	PPL 0.6	WHITE BRUSH
	445564	2	PPL 0.9	BLACK BRUSH
	445565	2	ABRASIVE	GREY BRUSH
	421819	2	-	PAD HOLDER
MxL 70 Bts	449785	2	PPL 0.3	BLUE BRUSH
	448012	2	PPL 0.6	WHITE BRUSH
	448013	2	PPL 0.9	BLACK BRUSH
	448014	2	ABRASIVE	GREY BRUSH

## TROUBLESHOOTING

This chapter lists the most common problems linked with the use of the machine. If you are unable to resolve the problems with the information given here, please contact your nearest assistance centre.

PROBLEM	POSSIBLE CAUSE	SOLUTION
THE MACHINE DOES NOT START	The main switch is set to "0".	Make sure the main switch is on "I". If it isn't, turn the key clockwise.
	Check that when switched on there are no alarm messages on the command display.	Stop the machine immediately and contact the technician of the specialised service centre, or press the SOS button if the FFM kit is installed.
	Make sure that the batteries are correctly connected to each other and that the battery connector is connected to the electrical system connector.	Connect the batteries correctly inside the machine (see <a href="#">INSERTING THE BATTERIES IN THE MACHINE</a> ).
	Check the charge level of the batteries.	If the battery charge level is critical, perform a complete recharge cycle (see paragraph <a href="#">CHARGING THE BATTERIES</a> ).
THE BATTERIES ARE NOT CHARGED CORRECTLY (VERSIONS WITH AN ON BOARD BATTERY CHARGER)	The plug on the battery charger's cable is not correctly inserted into the socket on the battery charger itself.	Reconnect the battery charger's power cable.
	The plug on the battery charger's power cable is not correctly inserted into the electrical outlet.	Check that the battery charger power supply cable plug is connected to the mains socket.
	The characteristics of the mains power supply do not correspond to those required by the battery charger.	Check that the characteristics in the battery charger plate are the same as those of the mains supply.
	The LEDs of the battery charger blink repeatedly.	Referring to the battery charger use and maintenance manual, check the meaning of the flashing signals that the battery charger emits during the battery recharge stage.
THE MACHINE HAS A VERY LOW WORK AUTONOMY	Check the battery charge level, check the symbol on the command display.	If the battery charge level is critical, perform a complete recharge cycle (see <a href="#">"RECHARGING THE BATTERIES"</a> ).
THE MACHINE DOES NOT MOVE	The machine does not start.	Read the section <a href="#">"THE MACHINE DOES NOT START"</a> .
	There is an issue on the drive pedal.	Contact your nearest service centre.
NOT ENOUGH DETERGENT SOLUTION ON THE BRUSH	The quantity of detergent solution in the water system is not sufficient for the work to be carried out.	Check that the amount of detergent solution present in the machine's water system is sufficient for the work to be carried out.
	Detergent solution filter obstructed.	Check the detergent solution filter isn't obstructed. If it is, clean it (see <a href="#">"CLEANING THE WATER SYSTEM FILTER"</a> ).
THE MACHINE DOES NOT CLEAN CORRECTLY	The machine does not start.	Read the section <a href="#">"THE MACHINE DOES NOT START"</a> .
	Not enough detergent solution comes out.	Read the section <a href="#">"NOT ENOUGH DETERGENT SOLUTION ON THE BRUSH"</a> .
	The brushes have not been inserted correctly in the machine.	Check that the disc brushes are correctly inserted into the machine (see <a href="#">"ASSEMBLING THE BRUSH (SCRUBBING VERSION)"</a> or <a href="#">"ASSEMBLING THE BRUSH (SWEEPING VERSION)"</a> ).
	The type of brush used is not suitable for the dirt to be cleaned.	Make sure that the brushes fitted on the machine are suitable for the work to be carried out. Read <a href="#">"CHOOSING AND USING THE BRUSHES"</a> .
	The brush bristles are excessively worn.	Check the wear of the brush and if necessary replace it (see <a href="#">"REPLACING THE BRUSH (SCRUBBING VERSION)"</a> or <a href="#">"REPLACING THE BRUSH (SWEEPING VERSION)"</a> ).

PROBLEM	POSSIBLE CAUSE	SOLUTION
THE SQUEEGEE DOES NOT DRY PERFECTLY	The vacuum unit is obstructed.	Make sure the squeegee is free of obstructions (read " <a href="#">CLEANING THE SQUEEGEE BODY</a> ").
		Make sure the vacuum tube is free of obstructions (see " <a href="#">CLEANING THE VACUUM TUBE</a> ").
		Make sure the vacuum cap filter is free of obstructions (see " <a href="#">CLEANING THE RECOVERY TANK FILTERS</a> ").
		Make sure the suction motor filter is free of obstructions (see " <a href="#">CLEANING THE RECOVERY TANK FILTERS</a> ").
THE SQUEEGEE DOES NOT DRY PERFECTLY	The cap on the recovery tank drainage tube is not properly positioned.	Check that the cap on the recovery tank drainage tube is positioned properly.
	The recovery tank lid is not positioned correctly.	Check that the recovery tank lid is properly positioned on the machine.
EXCESSIVE FOAM PRODUCTION	The detergent being used is not suitable.	Check that a low foam detergent has been used. If necessary, add a small quantity of anti-foam liquid to the recovery tank.
	The floor is not very dirty.	Dilute the detergent more.
THE MACHINE DOES NOT VACUUM CORRECTLY	The recovery tank is full.	Empty the recovery tank (read " <a href="#">EMPTYING THE RECOVERY TANK</a> ").
	The vacuum device is obstructed	Read the section " <a href="#">THE SQUEEGEE DOES NOT DRY PERFECTLY</a> ".

## EC DECLARATION OF CONFORMITY



The undersigned manufacturer:  
**FIMAP S.p.A.**  
 Via Invalidi del Lavoro, 1  
 37059 Santa Maria di Zevio (VR)  
 declares under its sole responsibility that the products

**FLOOR SCRUBBING MACHINES**  
**mod. MxL 65 Bt Plus - MxL 75 Bt Plus - MxL 85 Bt Plus - MxL 70 Bts Plus**

comply with the provisions of Directives:

- 2006/42/EC: Machinery Directive.
- 2014/30/EC: Electromagnetic compatibility directive.

They also comply with the following standards:

- EN 60335-1:2012/A11:2014
- EN 60335-2-72:2012
- EN 12100:2010
- EN 61000-6-2:2005/AC:2005
- EN 61000-6-3:2007/A1:2011/AC:2012
- EN 62233:2008/AC:2008

The person authorized to compile the technical file:

Mr. Giancarlo Ruffo  
 Via Invalidi del Lavoro, 1  
 37059 Santa Maria di Zevio (VR) - ITALY

Santa Maria di Zevio (VR), 14/01/2019

Fimap S.p.A.  
 Legal representative  
 Giancarlo Ruffo

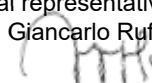

The undersigned manufacturer:  
**FIMAP S.p.A.**  
Via Invalidi del Lavoro, 1  
37059 Santa Maria di Zevio (VR)  
declares under its sole responsibility that the products

**FLOOR SCRUBBING MACHINES**  
**mod. MxL 65 Bt CB Plus - MxL 75 Bt CB Plus - MxL 85 Bt CB Plus - MxL 70 Bts CB Plus**

comply with the provisions of Directives:

- 2006/42/EC: Machinery Directive.
- 2014/35/EC: Low Voltage Directive.
- 2014/30/EC: Electromagnetic compatibility directive.

They also comply with the following standards:

- EN 60335-1:2012/A11:2014
- EN 60335-2-72:2012
- EN 12100:2010
- EN 60335-2-29:2004/A2:2010
- EN 61000-6-2:2005/AC:2005
- EN 61000-6-3:2007/A1:2011/AC:2012
- EN 61000-3-2:2014
- EN 61000-3-3:2013
- EN 55014-1:2006/A1:2009/A2:2011
- EN 55014-2:2015
- EN 62233:2008/AC:2008

The person authorized to compile the technical file:

Mr. Giancarlo Ruffo  
Via Invalidi del Lavoro, 1  
37059 Santa Maria di Zevio (VR) - ITALY

Santa Maria di Zevio (VR), 14/01/2019

Fimap S.p.A.  
Legal representative  
Giancarlo Ruffo







FIMAP spa - Via Invalidi del Lavoro, 1 - 37059 S. Maria di Zevio - Verona - Italy  
Tel. +39 045 6060411 – Fax +39 045 6060417 – E-mail: [fimap@fimap.com](mailto:fimap@fimap.com)  
[www.fimap.com](http://www.fimap.com)