

BMg Sanitizer

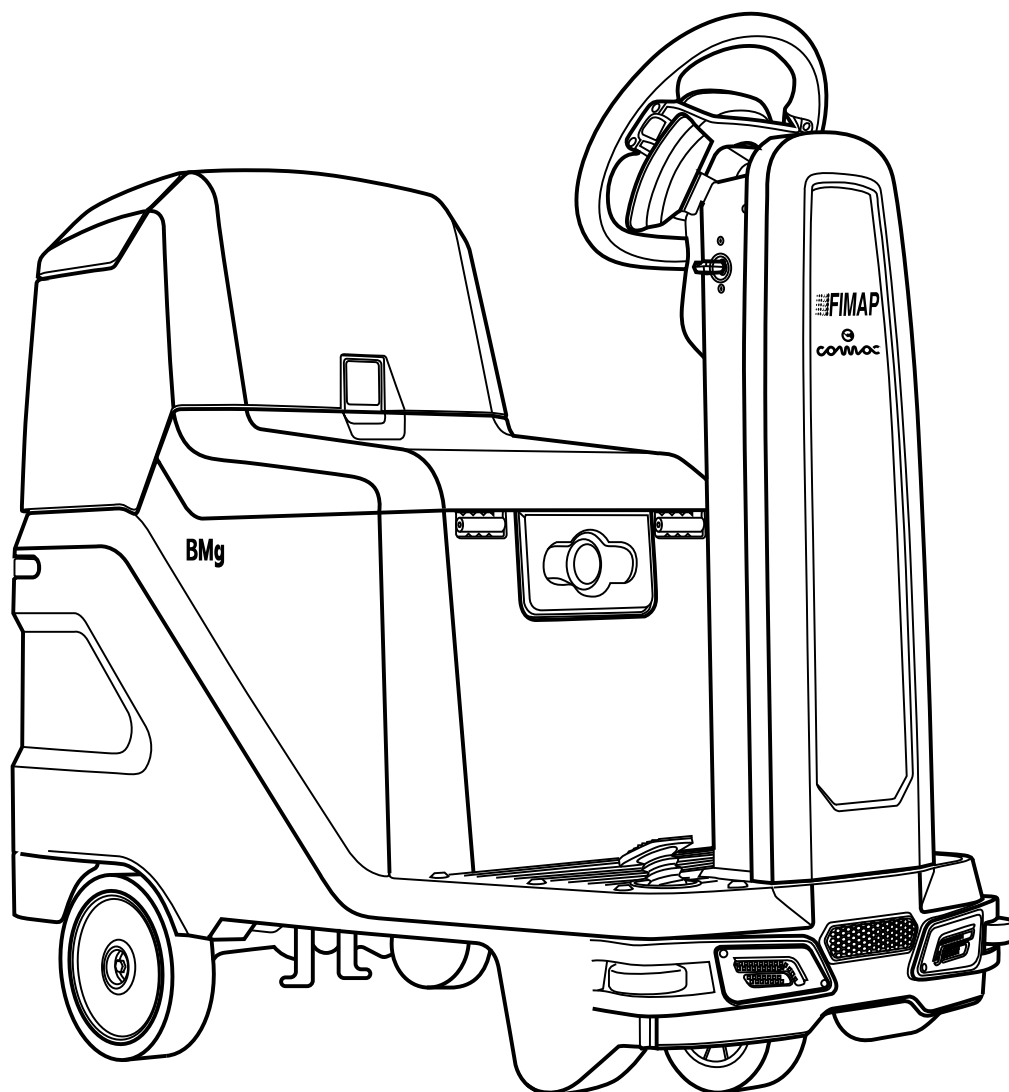

USE AND MAINTENANCE MANUAL

 **FIMAP**[®]

professional people



ORIGINAL INSTRUCTION DOC. 10095868 - Ver. AA - 03-2020

CONTENTS



CONTENTS	3
GENERAL SAFETY REGULATIONS	4
LOCATION OF THE MAIN MACHINE COMPONENTS	11
GENERAL DESCRIPTION	12
SYMBOLS USED IN THE MANUAL	12
DEFINITION OF LEVELS OF WARNING	12
PURPOSE AND CONTENT OF THE MANUAL	13
TARGET GROUP	13
PRESERVATION OF THE USER.....	13
ON CONSIGNMENT OF THE MACHINE	13
INTRODUCTORY COMMENT	13
IDENTIFICATION DATA	13
TECHNICAL DESCRIPTION.....	13
INTENDED USE.....	13
SAFETY.....	13
REGULATIONS.....	13
SERIAL NUMBER PLATE	14
TECHNICAL DATA	14
SYMBOLS AND LABELS USED ON THE MACHINE	14
SYMBOLS USED ON THE MACHINE.....	14
LABELS USED ON THE MACHINE.....	15
CONTROL DISPLAY.....	16
PREPARATION OF MACHINE	16
HANDLING THE PACKAGED MACHINE	16
HOW TO UNPACK THE MACHINE	16
HOW TO MOVE THE MACHINE	17
MACHINE SAFETY.....	17
BATTERY MAINTENANCE AND DISPOSAL.....	17
TYPE OF BATTERY TO BE USED	17
INSERTING THE BATTERIES INTO THE MACHINE.....	18
CONNECTING THE BATTERIES TO THE MACHINE SYSTEM.....	18
RECHARGING THE BATTERIES	18
FILLING THE SOLUTION TANK WITH WATER.....	19
SANITIZING SOLUTION.....	20
INSERTING WATER SYSTEM FILTER	20
PREPARING TO WORK	20
STARTING WORK	21
HOUR METER	21
BATTERY CHARGE LEVEL INDICATOR	21
ADDITIONAL FUNCTIONS	21
REVERSE FUNCTION.....	21
BUZZER.....	22
ALARM SCREEN	22
IMMEDIATE STOP BUTTON	22
AT THE END OF THE WORK	22
ROUTINE MAINTENANCE	23
EMPTYING THE SOLUTION TANK.....	23
CLEANING THE WATER SYSTEM FILTER	23
DISPOSAL	23
TROUBLESHOOTING	24
EC DECLARATION OF CONFORMITY	25

GENERAL SAFETY REGULATIONS



The following symbols are used to indicate any potentially hazardous situations. Always read this information carefully and take the necessary precautions to protect any people and/or objects that may be present.

Operator cooperation is paramount for accident prevention. No accident prevention programme can be effective without the full cooperation of the person directly responsible for the machine's operation. The majority of occupational accidents that happen either in the workplace or whilst moving are caused by failure to respect the most basic safety rules. An attentive, careful operator is most effective guarantee against accidents and is fundamental in order to implement any prevention programme.

KEEP THESE SAFETY WARNINGS WITH THE MACHINE USER MANUAL.

-  **DANGER:** indicates an imminent dangerous situation that, unless avoided, will result in death or serious injuries.
-  **WARNING:** Indicates a potentially dangerous situation that, unless avoided, could cause death or serious injury.
-  **ATTENTION:** Indicates a potentially dangerous situation that, unless avoided, could cause slight or moderate injuries.

BATTERY-POWERED MACHINE

-  **WARNING:**
 - To prevent unauthorised use of the machine, the power supply must be disconnected; switch off the machine using the main switch (if present, remove the key from the ignition) and disconnect the battery connector from the electrical system connector.
-  **ATTENTION:**
 - The machine must only be powered with a voltage equal to that shown on the serial number plate.
 - When doing maintenance work, switch off the machine using the main switch (if present, remove the key from the ignition) and disconnect the battery connector from the electrical system connector.
 - To manually move electric traction versions of the machine, the electric brake must be disengaged. Once the manual movement operations have been completed, the electric brake must be re-engaged. Never use the machine with the electric brake disengaged.
 - If the machine needs to be pushed for maintenance purposes (batteries absent; discharged batteries; etc.), never exceed the speed of 4 km/h.
 - If lead batteries (WET) have been installed on the machine, avoid tilting the machine beyond 30° with respect to the horizontal plane, as this could cause the highly corrosive liquid to leak out of the batteries.

- Avoid contact with the battery acid.
- Keep all metal objects away from the batteries.
- Use a non-conductive device for removing the battery.
- Use a hoist and suitable equipment when lifting the batteries.
- The battery must be installed by qualified personnel.
- Always observe the safety measures of the site regarding removing the battery.
- Remove the batteries if the machine needs to be tilted in order to perform maintenance procedures.
- The machine should not be left unattended at the end of its working cycle because of the presence of toxic-harmful materials inside it (batteries, etc.), which are subject to regulations regarding their disposal at special centres (see the chapter on Scrapping).

RECHARGING THE BATTERIES

DANGER:

- If the battery charger power cable is damaged or broken, it should be replaced by the charger manufacturer or authorised service personnel, or by another qualified person, in order to protect against hazards.
- The socket for the battery charger cable must have a prescribed earth connection.
- Keep sparks, flames, and incandescent materials at a safe distance from the batteries. Explosive gases are emitted during the charging phase.
- highly explosive hydrogen gas is generated while charging the batteries. Keep the recovery tank and/or the seat mounting plate in the maintenance position during the entire battery recharging cycle, and only perform the procedure in well-ventilated areas at a safe distance from any open flames.
- Before charging check that the electric cable that connects the battery charger to the batteries is not damaged, and if it is damaged do not use it and contact technical assistance.
- Before charging check that the electric cable that connects the battery charger to the mains is not damaged, and if it is damaged do not use it and contact technical assistance.
- Before starting to charge the batteries in versions with on-board battery charger, check there is no stagnant water or humidity in the battery charger socket.
- Do not disconnect the direct current cable of the battery charger from the socket of the machine when the battery charger is operating. This is necessary to prevent electric arcs forming. To disconnect the battery charger when charging, first disconnect the power cable from the mains socket.

WARNING:

- Do not use incompatible battery chargers since they could damage the batteries and potentially cause a fire.
- Before using the battery charger, make sure that the frequency and the voltage indicated on the battery charger serial number plate or in the charger user manual in versions with on-board battery charger (enclosed with the machine documentation) match the mains voltage.

- Keep the battery charger's cable at a safe distance from any hot surfaces.
- Never smoke in the machine's vicinity while the batteries are charging.
- Carefully read the user manual of the battery charger you want to use before recharging.

USING THE MACHINE



DANGER:

- In case of danger, act promptly by pressing the emergency button (if present) or disconnecting the battery connector from the electrical system connector.
- If the machine is used in dangerous areas (e.g. petrol stations), the relative safety standards must be observed. It is forbidden to use the machine in environments with a potentially explosive atmosphere.



WARNING:

- The machine must be exclusively used by authorised, trained personnel.
- Always use the machine in compliance with its intended use, taking into consideration local conditions and looking out for the presence of others when working, especially children.
- This machine should not be used by persons (including children) with physical, sensorial or mental impairments and by persons with little experience and/or little knowledge of the machine itself.
- Do not use the machine on surfaces with a slope greater than the one indicated on the serial number plate.
- The machine cannot be used on uneven or bumpy floors. Do not use the machine on slopes.
- In the event of a fire, use a powder extinguisher. Do not use water.
- Adapt the speed to the adhesion conditions.
- Do not use the machine if you do not have the requisite knowledge or authorisation.
- Do not use the machine if these safety warnings and the machine user manual have not been read and understood.
- Do not use the machine under the influence of alcohol or drugs.
- Do not use the machine when using a mobile phone or other types of electronic devices.
- Do not use the machine if it is not working correctly.
- Do not use the machine in areas where there are inflammable vapours or liquids or combustible powders.
- Do not use the machine in areas where it is too dark to see the controls or operate the machine safely, unless the work lights or the front headlights are on (if present).

 **ATTENTION:**

- Children must be supervised to ensure they do not play with the machine.
- During the working of the machine, pay attention to other people and especially to children.
- Read the labels on the machine carefully. Do not cover them for any reason, and replace them immediately if they become damaged.
- The machine must only be used and stored in an enclosed or covered environment.
- The machine must not be used or stored outdoors in damp conditions or directly exposed to rain.
- The machine does not cause harmful vibrations.
- Only use the machine in accordance with the instructions set out in these safety warnings and in the machine user manual.
- Reduce speed on slopes and dangerous corners.
- Always follow the instructions for mixing, use and disposal on the containers of the chemical substances.
- Always take appropriate measures to protect any individuals and/or objects that may be present while using this machine.
- Be careful to avoid collisions with shelving or scaffolding, above all if there is a risk of objects falling from heights.
- Do not place any liquid containers on the machine.
- The machine must only be used in temperatures ranging from +10 °C to +40 °C. The humidity level must be between 30% and 95%.
- When using disinfectants to sanitize areas, always follow the instructions and respect the warnings indicated on the container labels.
- Before handling disinfectants for sanitizing areas, operators are advised to put on the appropriate PPE (Personal Protective Equipment), suitable for the work to be carried out.
- In the event of a fire, use a powder fire extinguisher if possible, and avoid the use of water.
- Do not allow any objects to penetrate into the machine's openings. Do not use the machine if the openings are obstructed.
- Keep the machine's openings free of any dust, lint, hairs, or any other foreign materials that could reduce the airflow.
- Do not remove or alter any labels affixed to the machine.
- This machine has not been made for external use but internal locations only.
- Before starting to work check that there are no leaks.
- Before starting to work check that all the safety devices have been installed and are working correctly.
- Take all due precautions so that hair, jewellery, loose clothing do not get entangled in the machine's moving parts.
- Only use the machine in well-lit areas.

DEACTIVATION OF THE MACHINE

WARNING:

- Always protect the machine against sunlight, rain, and other atmospheric agents, both while it is stationary and while it is in function. Store the machine in a dry, sheltered place: this machine is only designed for use under dry conditions, and must not be used or stored outdoors under humid conditions.
- Do not park the machine near combustible materials, powders, gases or liquids.
- Stop the machine on a flat surface.
- If the machine is left unattended, it must be protected from any accidental movements

ATTENTION:

- The machine must only be stored in temperatures ranging from +10 °C to +40 °C. The humidity level must be between 30% and 95%.

MAINTENANCE

DANGER:

- In order to avoid short-circuits when working in the vicinity of electrical components, do the following: avoid the use of non-insulated tools; do not place or allow metallic objects to fall upon the electrically powered components; remove any rings, watches and/or clothing with metallic parts that might come into contact with the electrically powered components.
- do not work underneath the raised machine without adequate fixed safety supports.

WARNING:

- The cleaning and maintenance to be carried out by the user must not be performed by unsupervised children.
- Read all the relevant instructions carefully before performing any maintenance/repair operations.
- If the machine does not work properly, check this is not caused by failure to carry out maintenance. Otherwise, ask for intervention of the authorised technical assistance centre.
- Restore all electrical connections after any maintenance interventions.

ATTENTION:

- Avoid contact with moving parts. Do not wear loose clothing or jewellery and tie long hair back.
- Block the wheels before lifting the machine.

- Lift the machine with equipment that can sustain the weight to be lifted.
- Never tamper with the machine's protection devices for any reason; always follow the supplied routine maintenance instructions scrupulously.
- If any parts need to be replaced, always request ORIGINAL spare parts from an authorized Dealer or Retailer.
- In order to ensure the machine's safety and proper functionality, always have the scheduled maintenance interventions (specified in the appropriate section of this Manual) performed by authorized personnel or by an authorized Service Centre.
- Do not wash the machine with direct jets of water, pressurised water or with corrosive substances, and do not wet it in the vicinity of electrical components.
- Have the machine checked by an authorised technical assistance centre every year.
- When disposing of consumable materials, observe the laws and regulations in force. Once the machine has reached the end of its service life, the materials contained within it must be disposed of in an appropriate manner, keeping in mind that the machine itself has been built using fully recyclable materials.
- All repairs must be carried out by qualified personnel.
- Do not physically change the design characteristics of the machine.
- Use spare parts provided by authorised service centres.
- Wear personal protective equipment as required and as suggested in the manual.

TRANSPORT

WARNING:

- Drain both tanks before transport.
- Use a ramp, a truck or a trailer that can support the weight of the machine and the operator.
- The ramp for placing the machine on the transport vehicle should have such a slope that the machine does not get damaged.
- Secure the device according to the directives in force in the country of use, so that it cannot slide or tip over when being transported.
- In versions with electric traction, make sure the electric brake is correctly engaged after loading the machine onto the transport vehicle.

ATTENTION:

- Use caution when moving the machine under temperatures below freezing. The water contained in the water recovery tank or in the pipes could freeze, and could seriously damage the machine itself.

RIDE-ON MACHINES



WARNING:

- Do not use the machine in areas where there is a risk of falling objects, unless the machine is equipped with an overhead guard (optional).
- To place the machine on the transport vehicle use a pulley. Do not drive the machine on or off a truck or trailer.
- Engage the parking brake after loading the machine onto the transport vehicle.



ATTENTION:

- Reduce speed before making a turn.
- Keep all parts of your body inside when the machine is moving.
- Be careful when reversing.
- Do not transport passengers. Do not use the machine as a means of transport.
- If the machine is to be used in the presence of other individuals, aside from the operator, the beacon light (optional) must be utilized.
- This machine has not been approved for use on public streets or roadways.
- Do not push or tow the machine without an operator on the seat who can control the machine.
- Before starting work check that the brakes and steering are working correctly.
- Before starting work adjust the seat and steering wheel, and also the seat belt if there is one.

LOCATION OF THE MAIN MACHINE COMPONENTS

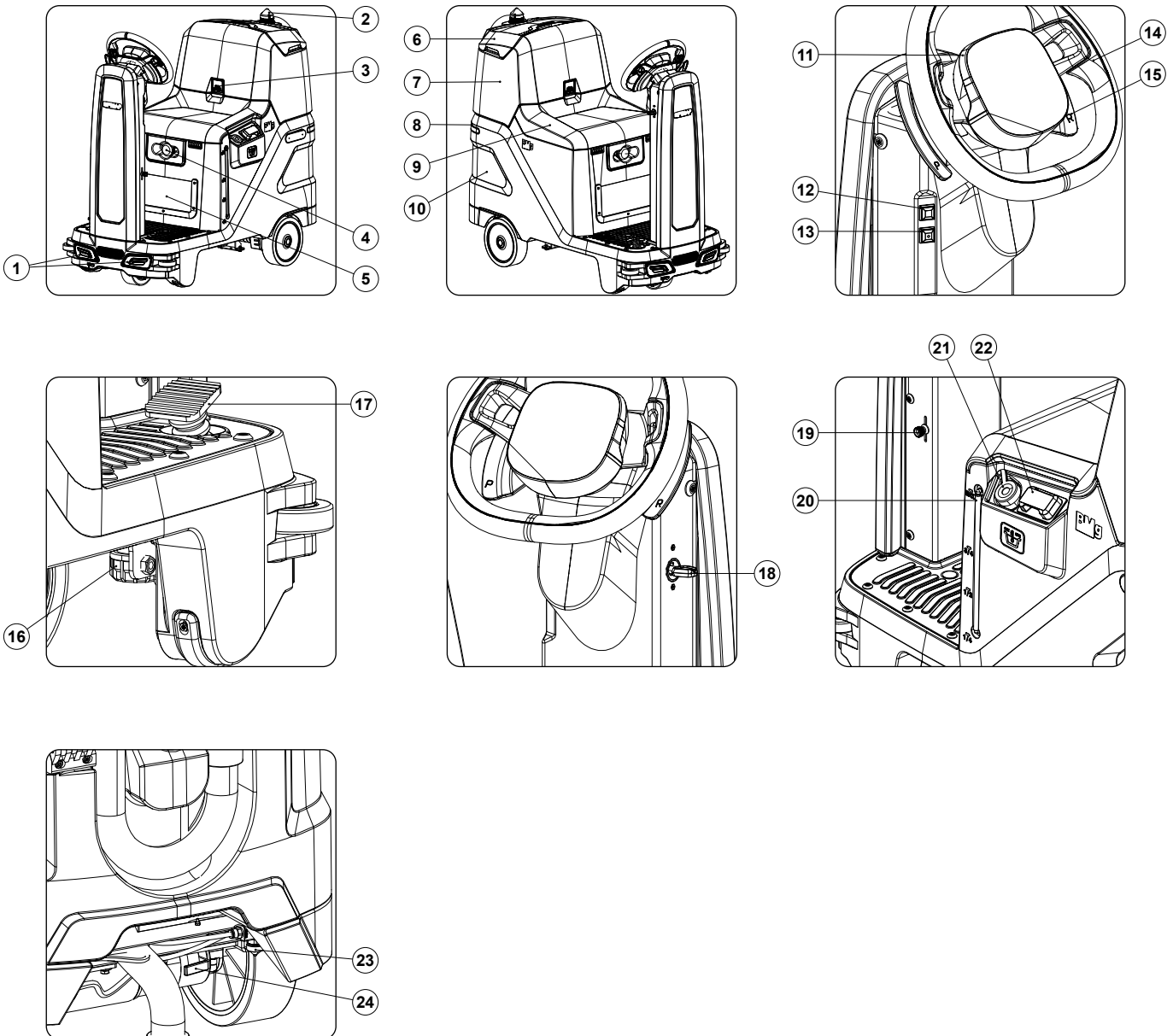















The machine's main components are the following:

- | | |
|---|--|
| <ol style="list-style-type: none"> 1. Front working lights. 2. Blinking light. 3. Recovery tank rotation stop lever. 4. Emergency button. 5. Object holder net. 6. Recovery tank lid. 7. Recovery tank. 8. Tail lights. 9. Operator's seat. 10. Sanitizing solution tank. 11. Command display. | <ol style="list-style-type: none"> 12. Horn button. 13. Spray kit control button. 14. Steering wheel. 15. Reverse gear selection lever. 16. Sanitizing solution filter. 17. Drive pedal. 18. Main key switch. 19. Sanitizing solution adjustment knob. 20. Sanitizing solution tank level hose. 21. Sanitizing solution tank rapid filling hose. 22. Sanitizing solution tank dosing cap. 23. Spray nozzle. 24. Electric brake control lever. |
|---|--|





GENERAL DESCRIPTION

The descriptions contained in this document are not binding. The company therefore reserves the right to make any modifications at any time to elements, details, or accessory supply, as considered necessary for reasons of improvement or manufacturing/commercial requirements. The reproduction, even partial, of the text and drawings contained in this document is prohibited by law. **The company reserves the right to make any technical and/or supply modifications. The images are shown as reference only and are not binding as to the actual design and/or equipment.**

SYMBOLS USED IN THE MANUAL

	Open book symbol with an "i": Indicates the need to consult the instruction manual.
	Open book symbol: Tells the operator to read the user manual before using the device.
	Covered place symbol: The operations preceded by this symbol must always be carried out in a dry, covered area.
	Information symbol: Indicates additional information for the operator, to improve the use of the device.
	Warning symbol: Carefully read the sections preceded by this symbol meticulously following the instructions indicated for the safety of the operator and the device.
	Danger symbol (corrosive substances): The operator should always wear protective gloves to avoid the risk of serious injury to the hands caused by corrosive substances.
	Danger symbol (battery acid leakage): Indicates the danger of leaking acid or acid fumes from the batteries while they are being recharged.
	Danger symbol (moving carriages): Indicates that the packed product should be handled with suitable carriages that conform to legal requirements.
	Mandatory room ventilation symbol: Informs the operator that the room must be ventilated while the batteries are being recharged.
	Symbol indicating the compulsory use of protective gloves: Indicates that the operator should always wear protective gloves, to avoid the risk of serious injury to his hands from sharp objects.
	Symbol indicating the compulsory use of tools: Informs the operator of the need to use tools not included with the machine.
	Symbol indicating a treading ban: Informs the operator that it is forbidden to tread on machine components, as this could lead to serious injury.
	Recycling symbol: Tells the operator to carry out the operations in compliance with environmental regulations in force in the place where the appliance is being used.
	Disposal symbol: Carefully read the sections marked with this symbol for disposing of the appliance.

DEFINITION OF LEVELS OF WARNING

-  **DANGER:** indicates an imminent dangerous situation that, unless avoided, will result in death or serious injuries.
-  **WARNING:** Indicates a potentially dangerous situation that, unless avoided, could cause death or serious injury.
-  **ATTENTION:** Indicates a potentially dangerous situation that, unless avoided, could cause slight or moderate injuries.
-  **N.B.:** instructs the reader to pay particular attention to the topic that follows.

PURPOSE AND CONTENT OF THE MANUAL

The aim of this manual is to provide customers with all the information needed to use the machine in the safest, most appropriate and most autonomous way. This includes information concerning technical aspects, safety, operation, downtime, maintenance, spare parts and scrapping. The operators and qualified technicians must carefully read the instructions in this manual before carrying out any operations on the machine. If in doubt about the correct interpretation of instructions, contact your nearest FIMAP Customer Service Centre to obtain the necessary clarifications.

TARGET GROUP

This manual is written both for operators and for qualified machine maintenance technicians. Operators must not perform operations that should be carried out by qualified technicians. The manufacturer is not liable for damages resulting from failure to comply with this veto.

PRESERVATION OF THE USER

The USE AND MAINTENANCE MANUAL must be stored in its special pouch close to the machine, protected from liquids and anything else that could compromise its legibility.

ON CONSIGNMENT OF THE MACHINE

When the machine is consigned to the customer, an immediate check must be performed to ensure all the material mentioned in the shipping documents has been received, and also to check the machine has not suffered damage during transportation. If this is the case, the carrier must ascertain the extent of the damage at once, informing our customer service office. It is only by prompt action of this type that the missing material can be obtained, and compensation for damage successfully claimed.

INTRODUCTORY COMMENT

Any machine can only work properly and effectively if used correctly and kept in full working order by carrying out the maintenance operations described in the attached documentation. We therefore suggest you read this instruction booklet carefully and read it again whenever difficulties arise while using the machine. If necessary, remember that our assistance service (organised in collaboration with our dealers) is always available for advice or direct intervention.

IDENTIFICATION DATA

For technical assistance or to request replacement parts, always give the model, the version and the serial number (written on the relevant plate).

TECHNICAL DESCRIPTION

The **BMg Sanitizer** is a machine designed for the sanitization of floors which sprays special sanitizing products in areas with heavy footfall, thus reducing the presence of pathogenic material as it moves forwards. **The machine must only be used for this purpose.**

INTENDED USE

This machine is designed and built for sanitizing floors in commercial, civil and industrial environments, in proven safety conditions, and must be used by a qualified operator. The machine is only suitable for use in closed (or at least covered) places.



ATTENTION: the machine is not suitable for use in the rain, or under water jets.

SAFETY

Operator cooperation is paramount for accident prevention. No accident prevention programme can be effective without the full cooperation of the person directly responsible for machine operation. The majority of occupational accidents that happen either in the workplace or whilst moving are caused by failure to respect the most basic safety rules. An attentive, careful operator is most effective guarantee against accidents and is fundamental in order to implement any prevention programme.

REGULATIONS

All references to forwards and backwards, front and rear, right and left indicated in this manual should be understood as referring to the operator in a driving position with his hands on the steering wheel.

SERIAL NUMBER PLATE

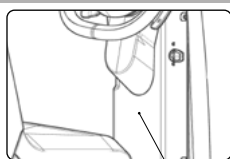

The serial number plate is located at the rear of the steering column, and indicates the machine's general characteristics, including its serial number. The serial number is a very important piece of information and should always be provided together with any request for assistance or when purchasing spare parts. The serial number plate contains the following:

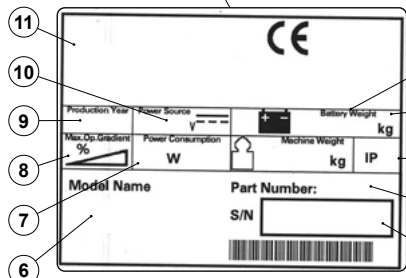

- 1) The weight of the batteries that power the machine (expressed in kg). See paragraph "TYPE OF BATTERY TO BE USED" on page 17.
- 2) The IP protection rating of the machine.
- 3) The gross weight of the machine (expressed in kg).
- 4) The machine ID code.
- 5) The machine serial number.
- 6) The machine ID name.
- 7) The nominal power consumed by the machine (expressed in W).
- 8) The maximum slope that the appliance can handle during work activities (expressed as %).
- 9) The year of machine manufacture.
- 10) The nominal voltage of the machine (expressed in V).
- 11) The commercial name of the machine, and the manufacturer's address.

TECHNICAL DATA

TECHNICAL DATA	U/M [KMS]	BMG SANITIZER
Rated machine power	kW	0,65
Minimum transport width	mm	630
Traction motor electrical properties (voltage - power)	V / W	24 - 300
Compressor electrical properties (voltage - power)	V / W	24 - 350
Maximum slope during work with GVW	%	17
Maximum speed during transport	km/h	5,5
Recommended speed during work	km/h	2,8
Maximum solution tank capacity	l	51
Minimum inversion footprint	mm	1830
Machine dimensions (length - height - width)	mm	1285 1189 630
Battery compartment dimensions (length - height - width)	mm	350 190 310
Machine weight when empty	kg	128
Transported machine weight	kg	210
GVW	kg	336
Sound pressure level in operator seat [ISO 11201] (L_{pA})	dB	<70
Uncertainty K_{pA}	dB	1,5
Hand-arm vibrations [IEC 60335-2-72; IEC 62885-9; ISO 5349-1]	m/s ²	<2,5
Whole body vibrations [IEC 60335-2-72; IEC 62885-9; ISO 2631-1]	m/s ²	0,65
Vibration measurement uncertainty		4%

SYMBOLS AND LABELS USED ON THE MACHINE

SYMBOLS USED ON THE MACHINE



Filter body position symbol:

Applied to the front of the machine to indicate the position of the solution tank filter.

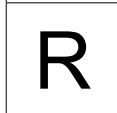

Reverse gear activation/deactivation lever position symbol:

Applied to the reverse gear activation/deactivation lever.



Symbol for maximum temperature for filling the solution tank:

Applied to the left-hand side of the machine's solution tank to indicate the maximum temperature of the water that can be used to safely fill the solution tank.



Solution tank filling symbol:

Located on the left side of the machine's solution tank to indicate the amount of sanitizing solution in the tank. The symbol on the side indicates that the tank is full to about a quarter of its capacity.



Solution tank filling symbol:

Located on the left side of the machine's solution tank to indicate the amount of sanitizing solution in the tank. The symbol on the side indicates that the tank is full to about a half of its capacity.



Solution tank filling symbol:

Located on the left side of the machine's solution tank to indicate the amount of sanitizing solution in the tank. The symbol on the side indicates that the tank is full to about three-quarters of its capacity.



Solution tank filling symbol:

Located on the left side of the machine's solution tank to indicate the amount of sanitizing solution in the tank. The symbol on the side indicates that the tank is full.

LABELS USED ON THE MACHINE



Main switch symbol:

Applied to the control panel, positioned on the front of the machine, to indicate the main switch.

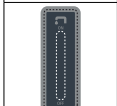

Label indicating sanitizing solution tap control:

Applied in the vicinity of the steering column to identify the sanitizing solution tap control lever.



Label indicating the need to read the Use and Maintenance Manual:

Applied in the vicinity of the steering column in order to remind the operator to read the user and maintenance manual before using the machine.



Warning label to read the user manual of the battery charger (versions with Battery charger):

Applied in the vicinity of the steering column indicating to read the user manual of the battery charger. Also indicates to pay attention to when to perform the charging cycle and how long it should last.



Battery charging sequence label (versions without Battery Charger):

Located near the steering column, indicating the sequence to perform to recharge the batteries correctly.



Visible daily maintenance label:

Applied near the steering column, indicating to tighten the machine's water tap after every work cycle and to clean the filters and the squeegee.



Warning label during battery charging:

Located near the steering column, listing the warnings to perform when recharging the batteries.



Water system filter maintenance label:

Applied near the water system filter to remind the user to clean it after each work cycle.



Label warning about the risk of crushed hands:

Indicates danger to hands due to crushing between two surfaces.



Acoustic signalling device control label:

Applied in the vicinity of the steering column to indicate the acoustic signalling device's control button.

CONTROL DISPLAY

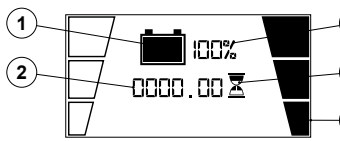
- 
- 3) The control display is divided in:
- 1) Battery charge level symbol, see paragraph "BATTERY CHARGE LEVEL INDICATOR" on page 21.
 - 2) Machine hours of use (expressed in a numerical value), see paragraph "HOUR METER" on page 21.
 - 3) Battery charge percentage (expressed in a numerical value, see paragraph "BATTERY CHARGE LEVEL INDICATOR" on page 21.
 - 4) Hourglass symbol which refers to the machine's hour meter, see paragraph "HOUR METER" on page 21.
- Forward speed level of the machine.

PREPARATION OF MACHINE

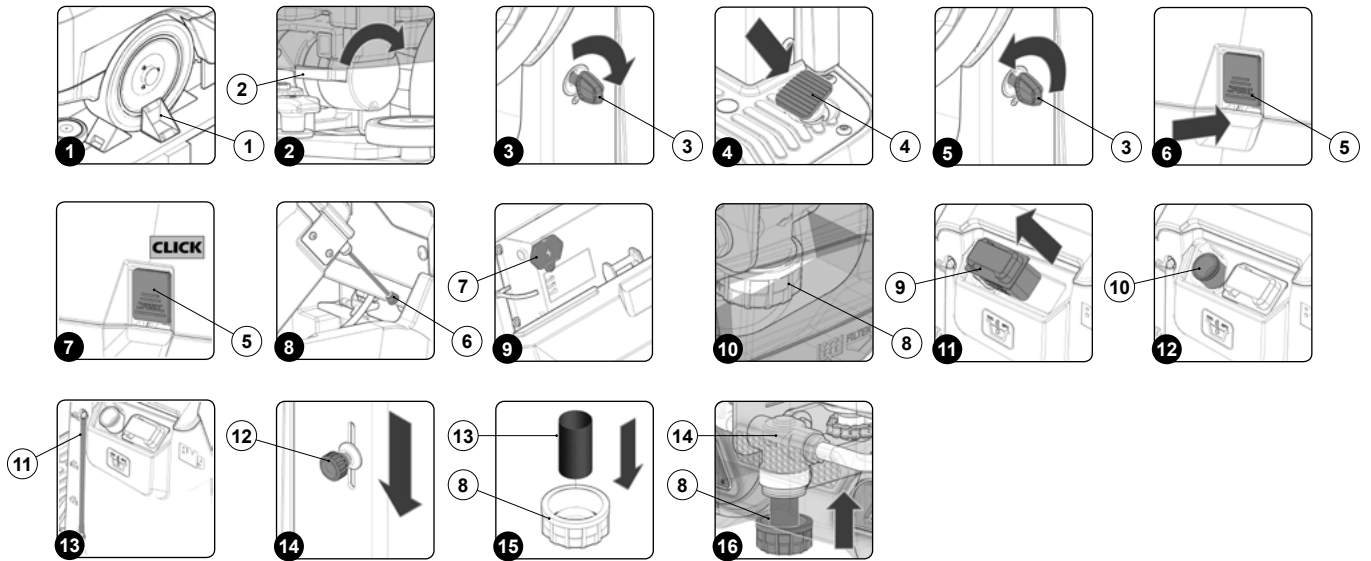

HANDLING THE PACKAGED MACHINE

The machine's overall weight including packaging is 173Kg. The external dimensions of the package are: width 750mm; length 1460mm and height 1385mm.

i **N.B.:** it is recommended that all the packaging components be kept for any future machine transportation.

⚠ **DANGER:** Move the packaged product with handling equipment that complies with legal requirements regarding size and mass of the packaging.

HOW TO UNPACK THE MACHINE

The machine is shipped in specific packaging. To remove it, proceed as follows:

1. Place the lower part of the outer packaging in contact with the floor.

i **N.B.:** use the pictograms printed on the box as a reference.

2. Remove the outer package.

⚠ **WARNING:** the machine is contained in specific packaging materials, whose elements (plastic bags, staples, etc.) can pose potential hazards, and must not be left within reach of children, disabled persons, etc.

👤 **ATTENTION:** It is recommended to wear the appropriate PPE (Personal Protective Equipment), suitable for the work to be carried out.

3. Insert a ramp in the rear part of the machine.

⚠ **ATTENTION:** the ramp gradient must not be such as to cause damage to the machine as it comes down.

4. The machine is fixed to the pallet with wedges (1) that block the wheels (**Fig.1**). Remove these wedges.
5. Move to the right rear part of the machine and check that the electro-brake, present in the traction gear motor, is not engaged. Turn the lever (2) clockwise (**Fig.2**).
6. Drive the machine down the ramp.

⚠ **ATTENTION:** during this operation, check there are no people or objects near the machine.

HOW TO MOVE THE MACHINE

To transport the machine safely, proceed as follows:

 **DANGER:** before starting any task, make sure the current regulations concerning the safe transport of dangerous substances are scrupulously observed.

1. Make sure the solution tank is empty. If it isn't, empty it completely. See paragraph "EMPTYING THE SOLUTION TANK" on page 23.
2. Sit on the driver's seat.
3. Insert the key (3) into the main switch on the control panel. Move the main switch to position "I" (**Fig.3**) by turning the key a quarter turn clockwise.
4. Press the drive pedal (4) (**Fig.4**) to begin moving the machine.
5. Use a ramp to move the machine up onto the transport vehicle.

 **ATTENTION:** during this operation, check there are no people or objects near the machine.

 **N.B.:** the ramp gradient must not be such as to cause damage to the machine as it goes up.

6. Position the machine on the means of transport, and set the main switch to "0" by turning the key (3) a quarter turn anti-clockwise (**Fig.5**). Remove the key from the instrument panel.
7. Get off the machine.
8. Press the recovery tank release lever (5) and turn the recovery tank into the maintenance position (**Fig. 6**).

 **ATTENTION:** the following operations must be carried out by qualified personnel. An incorrect connection of the connector may cause a malfunction of the device.

9. Disconnect the electrical connector from the machine's general system.
10. Rotate the recovery tank into the work position. Make sure that the recovery tank retainer system is correctly engaged.

 **WARNING:** secure the device according to the directives in force in the country of use, so that it cannot slide or tip over.

MACHINE SAFETY

To ensure that work is carried out in the best safety conditions, proceed as follows:

1. Take the machine to the maintenance area.

 **WARNING:** The place designated for this operation must comply with current regulations concerning safety at work and current environmental protection regulations.

2. Make sure the solution tank is empty. If it isn't, empty it completely. See paragraph "EMPTYING THE SOLUTION TANK" on page 23.
3. Bring the main switch to the "0" position by turning the key (3) a quarter turn anti-clockwise (**Fig.5**). Remove the key from the instrument panel.
4. Get off the machine.
5. Press the recovery tank release lever (5) and turn the recovery tank into the maintenance position (**Fig. 6**).
6. Disconnect the general system connector from the battery connector.

 **WARNING:** It is recommended that all electrical disconnection operations be carried out by expert personnel, trained at the specialised assistance centre.

7. Rotate the recovery tank into the work position. Make sure that the recovery tank retainer system is correctly engaged (**Fig. 8**).

BATTERY MAINTENANCE AND DISPOSAL

For battery maintenance and recharging, respect the instructions provided by the battery manufacturer. When the batteries reach the end of their service life, they must be disconnected by a specialised and properly trained operator, and must be subsequently removed from the battery compartment using suitable lifting devices.



N.B.: Dead batteries are classified as dangerous waste and as such must be delivered to an authorised body for disposal.

TYPE OF BATTERY TO BE USED

CODE	DESCRIPTION
410875	TP BATTERY 12V 110Ah (ACID)
410877	MFP BATTERY 12V 105Ah (GEL)

Used batteries must meet the requirements set out in DIN EN 50272-3 "Traction batteries for industrial trucks".

To ensure proper performance, the machine must be powered with 24V.

The machine can be powered with the batteries listed in the table to the side.

 **N.B.:** The use of two 12TP110 batteries is recommended.

INSERTING THE BATTERIES INTO THE MACHINE

The batteries must be housed in the special compartment inside the machine and should be handled using lifting equipment that is suitable both regard to the weight and the coupling system used.

 **ATTENTION:** It is recommended to wear the appropriate PPE (Personal Protective Equipment), suitable for the work to be carried out.

 **ATTENTION:** to prevent an accidental short circuit use insulated tools to connect the batteries, and do not place or drop metal objects on the battery. Remove rings, watches and any clothing with metal parts that may come into contact with the battery terminals.

The various phases for inserting the batteries in the battery compartment are as follows:

1. Carry out the steps necessary to secure the machine, see paragraph "MACHINE SAFETY" on page 17.
2. Press the recovery tank release lever (5), turn the recovery tank into the maintenance position (**Fig. 6**) and turn the recovery tank as far as it will go.

 **N.B.:** for battery maintenance and daily recharging, you must fully respect the indications provided by the manufacturer or retailer.

 **ATTENTION:** all installation and maintenance operations must be carried out by specialised personnel.

 **N.B.:** before installing the battery, clean the battery compartment.

 **N.B.:** Check that the connectors on the cables supplied are functioning correctly.

 **ATTENTION:** check that the characteristics of the battery that you are looking to use are appropriate for the type of work to be performed.

 **ATTENTION:** Check the battery charge and the condition of the contacts on the battery.

 **N.B.:** you are advised to only lift and move the batteries with lifting and transportation means suitable for the specific weight and size

 **ATTENTION:** the lifting hooks must not damage the blocks, connectors or cables.

 **N.B.:** Before inserting the batteries into the machine, remember to cover the terminals with a little grease to protect them against external corrosion.

3. House the batteries in the compartment, positioning the poles "+" and "-" opposite each other.

CONNECTING THE BATTERIES TO THE MACHINE SYSTEM

 **WARNING:** The batteries should be connected so as to obtain a total voltage of 24V.

 **WARNING:** It is recommended that all installation and maintenance operations be carried out by expert personnel, trained at the specialised assistance centre.

 **WARNING:** to prevent an accidental short circuit use insulated tools to connect the batteries, and do not place or drop metal objects on the battery. Remove rings, watches and any clothing with metal parts that may come into contact with the battery terminals.

The various phases for inserting the batteries in the battery compartment are as follows:

1. Using the jumper cable supplied with the machine, connect the batteries to the "+" and "-" poles in series.
2. Connect the battery connector cable to the "+" and "-" poles in order to obtain the terminal voltage of 24V.
3. Connect the electrical system connector to the battery connector.

RECHARGING THE BATTERIES

The batteries must be charged prior to first use, and whenever they no longer provide sufficient power to perform the desired work.

 **ATTENTION:** The control board and the battery charger, if present on-board, are set for lead - acid batteries, contact the nearest FIMAP assistance centre to modify the setting if you want to use gel batteries.

 **ATTENTION:** to avoid any permanent damage to the batteries, it is essential to avoid their complete discharge; begin recharging them within a few minutes of noting the "discharged batteries" signal.

 **ATTENTION:** Never leave the batteries completely discharged, even if the machine is not being used.

1. Bring the machine to the battery recharging area.

 **ATTENTION:** park the machine in an enclosed place, on a flat and level surface; near the machine there must be no objects that could either damage it, or be damaged through contact with it.

 **DANGER:** the room used to recharge the batteries must be adequately ventilated to prevent the accumulation of gases that leak from batteries.

2. Carry out the steps necessary to secure the machine, see paragraph "MACHINE SAFETY" on page 17.
3. Press the recovery tank release lever (5) and turn the recovery tank into the maintenance position (**Fig. 6**).

To recharge the batteries without the built-in battery charger, proceed as follows:

 **WARNING:** It is recommended that all installation and maintenance operations be carried out by expert personnel, trained at the specialised assistance centre.

- Disconnect the electric system connector from the battery connector.
- Connect the external battery charger cable to the battery connector.

 **N.B.:** the coupling connector of the battery charger is consigned inside the bag containing this instruction booklet, and must be assembled on the cables of the battery charger as indicated in the instructions.

 **DANGER:** before connecting the batteries to the battery charger, make sure it is suitable for the batteries used.

 **N.B.:** carefully read the use and maintenance instructions of the battery charger that is used for charging.

- Rotate the recovery tank until the foot (6) on the gas spring is resting on the solution tank (**Fig.8**).

 **ATTENTION:** keep the recovery tank open for the duration of the battery recharging cycle to allow gas fumes to escape.

- Once the recharge cycle has been completed, rotate the recovery tank to the maintenance position and disconnect the battery charger's cable from the battery connector.
- Connect the electrical system connector to the battery connector.
- Rotate the recovery tank into the work position. Make sure that the recovery tank retainer system is correctly engaged (**Fig. 8**).

To recharge the batteries with the on-board battery charger proceed as follows:

 **WARNING:** It is recommended that all installation and maintenance operations be carried out by expert personnel, trained at the specialised assistance centre.

 **N.B.:** Carefully read the use and maintenance instructions of the battery charger that is used for charging, this document is delivered along with the machine.

- Rotate the recovery tank until the foot (6) on the gas spring is resting on the solution tank (**Fig.8**).
- Remove the cap (7) from the battery charger socket (**Fig.9**).

 **ATTENTION:** before connecting the batteries to the battery charger, make sure it is suitable for the batteries used.

 **WARNING:** Before inserting the battery charger power cable into the socket, verify that there is no condensate or other forms of liquids.

 **N.B.:** the battery charger power cable is delivered inside the bag containing this instruction booklet.

- Plug the battery charger cable into the mains socket.
- Connect the battery charger's power cable to the socket on the battery charger itself.

 **ATTENTION:** keep the recovery tank open for the duration of the battery recharging cycle to allow gas fumes to escape.

- When the recharge cycle is complete, disconnect the battery charger cable from the mains.
- Disconnect the battery charger's power cable from the socket on the battery charger itself.
- Reposition the cap (7) in the socket of the battery charger (**Fig.9**).
- Rotate the recovery tank into the work position. Make sure that the recovery tank retainer system is correctly engaged (**Fig. 8**).

FILLING THE SOLUTION TANK WITH WATER

Before filling the solution tank, carry out the following steps:

1. Take the machine to the usual place for filling the solution tank.
2. Carry out the steps necessary to secure the machine, see paragraph "MACHINE SAFETY" on page 17.
3. Move to the front of the machine and check that the water system filter cap (8) is tightened, otherwise tighten it (**Fig.10**).

The solution tank can be filled with water in two different ways:

- Removing the cap/measuring device (9) and filling the solution tank by means of a rubber hose or a bucket (**Fig.11**).
 - Using the filler hose (10) (**Fig.12**), which supports the water hose on its own. In this case, be sure to remove the cap/measuring device (9) in order to allow the air to vent properly.
4. Fill with clean water, at a temperature no higher than 50°C (122°F) and no lower than 10°C (50°F). The amount inside the tank can be seen by means of the level tube (11) on the left-hand side of the machine (**Fig.13**).

SANITIZING SOLUTION

After filling the solution tank with clean water, add the sanitizing chemical product to the tank in the concentration and manner indicated on the sanitizing product manufacturer's label.

⚠ ATTENTION: It is recommended to wear the appropriate PPE (Personal Protective Equipment), suitable for the work to be carried out.

INSERTING WATER SYSTEM FILTER

Before using the machine for the first time the water system filter needs to be reset, for shipping reasons the filter cartridge and the cap have been removed. To insert the filter cartridge in the water system filter body proceed as follows:

1. Take the machine to the maintenance area.
2. Carry out the steps necessary to secure the machine, see paragraph "MACHINE SAFETY" on page 17.

👤 ATTENTION: It is recommended to wear the appropriate PPE (Personal Protective Equipment), suitable for the work to be carried out.

3. Close the tap's output flow, and shift the knob (12) on the left hand side of the steering column (**Fig.14**) downward.
4. Move to the front of the machine, insert the filter cartridge (13) in the housing on the cap (8) (**Fig.15**).

📌 N.B.: The O-ring gasket in the filter cartridge should be inserted into its seat in the cap.

5. Screw the cap (8) onto the body of the sanitizing solution filter (14) (**Fig.16**).

PREPARING TO WORK

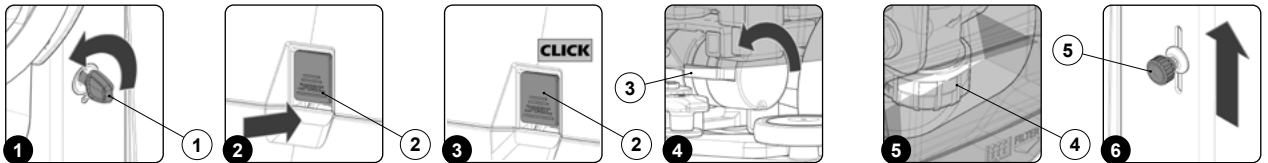

Before beginning to work, it is necessary to:

1. Check that the quantity of sanitizing solution in the solution tank is correct for the type of work to be carried out; if not, refill the solution tank. See paragraph "FILLING THE SOLUTION TANK WITH WATER" on page 19 and paragraph "SANITIZING SOLUTION" on page 20.
2. Check that the main switch is set to "0", turn the key (1) a quarter turn anti-clockwise (**Fig.1**). With the machine off, remove the key from the instrument panel.
3. Press the recovery tank release lever (2) and turn the recovery tank into the maintenance position (**Fig. 2**).

⚠ WARNING: It is recommended that all installation and maintenance operations be carried out by expert personnel, trained at the specialised assistance centre.

4. Connect the battery connector to the machine's general system connector.
5. Rotate the recovery tank into the work position. Make sure that the recovery tank retainer system is correctly engaged (**Fig. 3**).
6. Move to the right rear part of the machine and check that the electro-brake in the traction gear motor is engaged, turn the lever (3) clockwise (**Fig. 4**).
7. Move to the front of the machine and check that the water system filter cap (4) is closed, otherwise tighten it (**Fig.5**).
8. Move to the front left part of the machine and check that the water tap is opened completely, turn the knob (5) upwards (**Fig.6**).

STARTING WORK

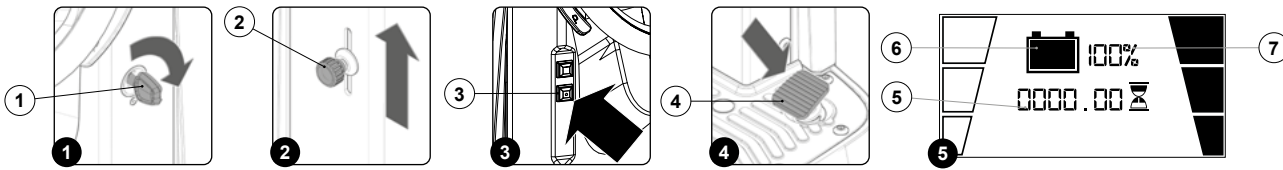

To start working, proceed as follows:

1. Carry out all the checks listed in the chapter "PREPARING TO WORK" on page 20.
2. Sit on the driver's seat.
3. Insert the key (1) into the main switch on the control panel. Set the main switch to "I" by turning the key a quarter turn clockwise (Fig.1).
4. Open the flow of sanitizing solution, using the knob (2) on the rear left side of the steering column (Fig.2).

i **N.B.:** Remember to open the flow of sanitizing solution fully, moving the knob (2) upwards as far as it will go.

5. Activate the sanitizing product spray function; to do this, press the button (3) (Fig.3).

i **N.B.:** if the LED on the button (3) is on, the spraying system is active; if the LED is off, the system is deactivated.

i **N.B.:** if you want to deactivate the spraying system, press button (3) again.

6. Press the drive pedal (4) to begin moving the machine (Fig. 4).

The machine will now begin to work with full efficiency until the battery is flat or until the sanitizing solution is used up.

i **N.B.:** If you the drive pedal is released during work, the machine will start to slow down and the sanitizing product pump will stop delivering the product into the machine's water circuit. The compressor will remain in operation for a few seconds when the drive pedal is released to allow the compressed air to expel the sanitizing product present in the machine's water circuit.

HOURLY METER

The machine control panel contains the control display (Fig.5), which shows the total usage time via a series of numbers (5). The numbers before the letter "h" identify the hours, while the numbers before the letter "m" identify the tenths of an hour (a tenth of an hour corresponds to six minutes).

BATTERY CHARGE LEVEL INDICATOR

The command display is in the control panel (Fig.5); at the centre you can see the battery charge level.

The indicator is composed of two charge level symbols, the first represented by a graphic symbol (6), the second by a number that indicates the charge percentage (7). The indicator is composed of 5 charge levels, each of which represents about 20% of residual charge. With a residual charge of 20% the graphic symbol starts to flash and after a few second it will appear in larger dimensions in the middle of the screen, under these conditions take the machine to the usual place to charge the batteries.

ADDITIONAL FUNCTIONS

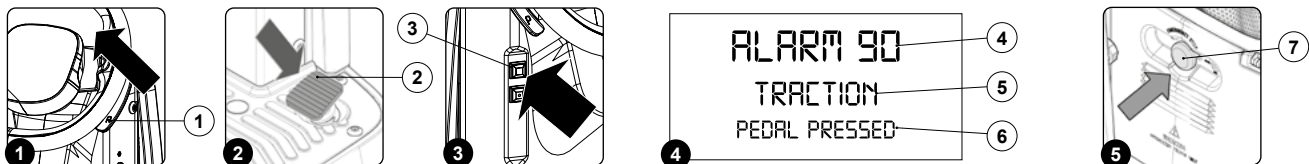

REVERSE FUNCTION

This machine is equipped with electronic traction control. To reverse, proceed as follows:

1. Engage the "REVERSE GEAR ACTIVATION/DEACTIVATION" lever (1) underneath the steering wheel (Fig.1).
2. Press the drive pedal (2) (Fig.2); in this manner the machine will begin to move in reverse.

⚠ **ATTENTION:** the reverse speed is lower than the forward speed to comply with current health and safety standards.

i **N.B.:** In order to disengage the reverse gear, disengage the lever (1) underneath the steering wheel (Fig.1).

i **N.B.:** Once the lever has been engaged (1), the acoustic signalling device will be activated in order to signal that the machine's reverse gear has been engaged.

i **N.B.:** If the machine is placed in reverse gear during sanitization, the pump in the machine's water system will stop delivering the product into the machine's water circuit.

i **N.B.:** If the machine is placed in reverse gear during sanitization, the compressor in the machine will continue to function.

BUZZER

The machine is equipped with a buzzer. if you need to sound a warning, just press the button (3) on the steering column (**Fig.3**).

ALARM SCREEN

When an error occurs, the corresponding alarm screen will appear on the control display (**Fig.4**).

The display of the alarm consists of a first flashing line relating to the code (4) and the source of the error (5), while the second line displays a summary (6) of the error description. The alarm screen will remain visible until the error is resolved.

When an error occurs, do as follows:

1. Stop the machine immediately.
2. If the error persists, switch off the machine, wait for at least ten seconds and switch on the machine.
3. If the error persists contact the nearest service centre.

IMMEDIATE STOP BUTTON

If any problems occur during the work, press the immediate stop button (7) located under the operator's seat (**Fig.5**). This function interrupts all functions that are active at that time.

Once you have stopped the machine and solved the problem, to resume work proceed as follows:

1. Turn the main machine switch to "0", turn the key a quarter turn anti-clockwise.
2. Turn the emergency stop switch to the idle position, moving the button (7) outwards.
3. Turn the main machine switch to "", turn the key a quarter turn clockwise.

AT THE END OF THE WORK

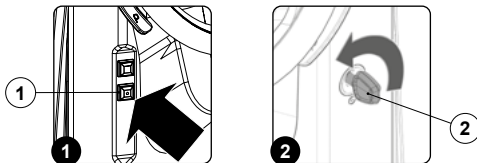

At the end of the work, and before carrying out any type of maintenance, perform the following operations:

1. Turn off the sanitizing product spray function; to do this, press the button (1) (**Fig.1**).

i **N.B.:** if the LED on the button (1) is on, the spraying system is active; if the LED is off, the system is deactivated.

2. Take the appliance to the dedicated dirty water drainage area.

⚠ WARNING: The place designated for this operation must comply with current regulations concerning safety at work and current environmental protection regulations.

3. Switch off the machine and turn the main switch (2) to position "0" by turning the key a quarter turn anti-clockwise (**Fig.2**). Remove the key from the instrument panel.
4. Carry out all the procedures listed in the chapter "ROUTINE MAINTENANCE" on page 23, indicated in the column entitled AT THE END OF THE WORK.
5. Once the maintenance operations are complete, take the machine to the designated storage location.

⚠ ATTENTION: Park the machine in an enclosed place, on a flat surface; near the machine there must be no objects that could either damage it, or be damaged through contact with it.

6. Secure the machine, see paragraph "MACHINE SAFETY" on page 17.

ROUTINE MAINTENANCE

Before carrying out any routine maintenance operations, proceed as follows:

1. Take the machine to the maintenance area.

WARNING: the place designated for this operation must comply with current regulations concerning safety at work and current environmental protection regulations.

2. Carry out the steps necessary to secure the machine, see paragraph "MACHINE SAFETY" on page 17.

ATTENTION: It is recommended to wear the appropriate PPE (Personal Protective Equipment), suitable for the work to be carried out.

TYPE OF MAINTENANCE	AT THE END OF THE WORK	DAILY	WEEKLY	BEFORE A LONG PERIOD OF NON-USE	TRANSPORT
EMPTYING THE SOLUTION TANK		X		X	X
CLEANING THE WATER SYSTEM FILTER		X		X	

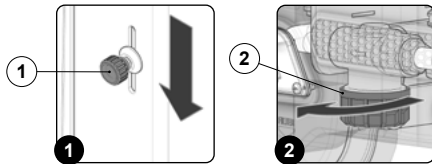

EMPTYING THE SOLUTION TANK

Proceed as follows to empty the solution tank:

1. Close the tap's output flow, and shift the knob (1) on the left hand side of the steering column (**Fig.1**) downward.
2. Remove the sanitizing solution filter cap (2) (**Fig.2**).
3. Open the tap's output flow, and shift the knob (1) on the left hand side of the steering column upward.
4. When the solution tank is empty, repeat the operations in the reverse order to reassemble all the parts.

CLEANING THE WATER SYSTEM FILTER

In order to clean the water system's filter, do the following:

1. Close the tap's output flow, and shift the knob (1) on the left hand side of the steering column (**Fig.1**) downward.
2. Remove the sanitizing solution filter cap (2) (**Fig.2**).
3. Rinse the filter cartridge under a jet of water, and use a brush to eliminate any impurities, if necessary.
4. Once the filter cartridge is clean, repeat the operations in the opposite order to reassemble all the parts.

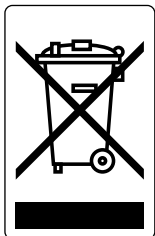

DISPOSAL

Proceed with scrapping the machine in accordance with the waste disposal regulations in force in the country in which the machine is being used.

TROUBLESHOOTING

This chapter lists the most common problems linked with the use of the machine. If you are unable to resolve the problems with the information given here, please contact your nearest assistance centre.

PROBLEM	POSSIBLE CAUSE	SOLUTION
THE MACHINE DOES NOT START	the machine is off.	Make sure that the main switch is in the "I" position, otherwise turn the key a quarter turn clockwise.
THE MACHINE IS NOT WORKING	Check that there are no alarm messages on the control display when the machine is switched on.	Stop the machine immediately, and contact a specialised service centre.
	Make sure that the batteries are correctly connected to each other and that the battery connector is connected to the electrical system connector.	See paragraphs "INSERTING THE BATTERIES INTO THE MACHINE" on page 18 and "CONNECTING THE BATTERIES TO THE MACHINE SYSTEM" on page 18.
	Check the charge level of the batteries.	If the battery charge level is critical, perform a complete charge cycle; see paragraph "RECHARGING THE BATTERIES" on page 18.
THE BATTERIES ARE NOT CHARGED CORRECTLY (VERSIONS WITHOUT AN ON BOARD BATTERY CHARGER)	The connector of the battery charger cable is not properly inserted in the battery connector.	Connect the battery charger cable connector to the battery connector again. It is recommended that all installation and maintenance operations be carried out by expert personnel, trained at the specialised assistance centre.
	The plug on the battery charger's power cable is not correctly inserted into the electrical outlet.	Check that the battery charger power supply cable plug is connected to the mains socket.
	The characteristics of the mains power supply do not correspond to those required by the battery charger.	Check that the characteristics in the battery charger plate are the same as those of the mains supply. Contact a service centre technician for more information.
	The LEDs of the battery charger blink repeatedly.	Referring to the battery charger use and maintenance manual, check the meaning of the flashing signals that the battery charger emits during the battery recharge stage.
THE BATTERIES ARE NOT CHARGED CORRECTLY (VERSIONS WITH AN ON BOARD BATTERY CHARGER)	The plug on the battery charger's cable is not correctly inserted into the socket on the battery charger itself.	Reconnect the battery charger's power cable. It is recommended that all installation and maintenance operations be carried out by expert personnel, trained at the specialised assistance centre.
	The plug on the battery charger's power cable is not correctly inserted into the electrical outlet.	Check that the battery charger power supply cable plug is connected to the mains socket.
	The characteristics of the mains power supply do not correspond to those required by the battery charger.	Check that the characteristics in the battery charger plate are the same as those of the mains supply. Contact a service centre technician for more information.
	The LEDs of the battery charger blink repeatedly.	Referring to the battery charger use and maintenance manual, check the meaning of the flashing signals that the battery charger emits during the battery recharge stage.
THE MACHINE HAS A VERY LOW WORK AUTONOMY	Check the battery charge level (check the symbol on the control display).	If the battery charge level is critical, perform a complete charge cycle; see paragraph "RECHARGING THE BATTERIES" on page 18.
SANITIZING SOLUTION SPRAY NOT SUFFICIENT	The quantity of sanitizing solution in the water system is not sufficient for the work to be carried out.	Check that the amount of sanitizing solution present in the machine water system is sufficient for the work to be carried out; if this is not the case, top it up. See paragraphs "FILLING THE SOLUTION TANK WITH WATER" on page 19 and "SANITIZING SOLUTION" on page 20.
	Sanitizing solution filter clogged.	Check that the sanitizing solution filter is not clogged; if it is, clean it. See paragraph "CLEANING THE WATER SYSTEM FILTER" on page 23.

EC DECLARATION OF CONFORMITY



The undersigned manufacturer:
FIMAP S.p.A.
Via Invalidi del Lavoro, 1
37059 Santa Maria di Zevio (VR)
declares under its sole responsibility that the products

MACHINE FOR SANITIZING FLOORS

COMAC-FIMAP mod. BMg Sanitizer CB

comply with the requirements of the following Directives:

- 2006/42/EC: Machinery Directive.
- 2014/35/EU: Low Voltage Directive.
- 2014/30/EU: Electromagnetic compatibility directive.

They also comply with the following standards:

- EN 60335-1:2012/A11:2014
- EN 60335-2-54:2008+A1:2015
- EN 12100:2010
- EN 60335-2-29:2004/A2:2010
- EN 61000-6-2:2005/AC:2005
- EN 61000-6-3:2007/A1:2011/AC:2012
- EN 61000-3-2:2014
- EN 61000-3-3:2013
- EN 55014-1:2006/A1:2009/A2:2011
- EN 55014-2:2015
- EN 62233:2008/AC:2008

The person authorized to compile the technical file:

Mr. Giancarlo Ruffo
Via Invalidi del Lavoro, 1
37059 Santa Maria di Zevio (VR) - ITALY

Santa Maria di Zevio (VR), 25/03/2020

Fimap S.p.A.
Legal representative
Giancarlo Ruffo

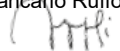

EC DECLARATION OF CONFORMITY



The undersigned manufacturer:
FIMAP S.p.A.
Via Invalidi del Lavoro, 1
37059 Santa Maria di Zevio (VR)
declares under its sole responsibility that the products

MACHINE FOR SANITIZING FLOORS

COMAC-FIMAP mod. BMg Sanitizer CB

comply with the requirements of the following Directives:

- 2006/42/EC: Machinery Directive.
- 2014/35/EU: Low Voltage Directive.
- 2014/30/EU: Electromagnetic compatibility directive.

They also comply with the following standards:

- EN 60335-1:2012/A11:2014
- EN 60335-2-54:2008+A1:2015
- EN 12100:2010
- EN 61000-6-2:2005/AC:2005
- EN 61000-6-3:2007/A1:2011/AC:2012
- EN 61000-3-2:2014
- EN 61000-3-3:2013
- EN 55014-1:2006/A1:2009/A2:2011
- EN 55014-2:2015
- EN 62233:2008/AC:2008

The person authorized to compile the technical file:

Mr. Giancarlo Ruffo
Via Invalidi del Lavoro, 1
37059 Santa Maria di Zevio (VR) - ITALY

Santa Maria di Zevio (VR), 25/03/2020

Fimap S.p.A.
Legal representative
Giancarlo Ruffo

 **FIMAP**[®]

COMAC
professional people

FIMAP S.p.A. - Via Invalidi del Lavoro, 1 - 37059 S. Maria di Zevio - Verona - Italy
Tel. +39 045 6060411 - Fax +39 045 6060417 - E-mail: fimap@fimap.com
www.fimap.com